

## CM CLARIFICATION #007 – Post Bid

April 25, 2018

### PROJECT: CNE Tahlequah Casino

Foreman Manhattan Team has added and/or revised the following documents for review and inclusion by all contractors within their Scope Package Proposal:

1. **Foreman Manhattan RFI #001 – “Underslab Waste and Grease Waste Piping”  
RFI RESPONSE ATTACHMENTS (Issued by James R. Childers Architect, Inc):**
  - a. Grease Waste Specification
  
2. **Foreman Manhattan RFI #009 – “Addendum 2 and Bid Package 2 Plumbing Schedule”  
RFI RESPONSE ATTACHMENTS (Issued by James R. Childers Architect, Inc):**
  - a. Sheet P0.4 “PLUMBING SCHEDULES” dated 3/27/18.
  
3. **Revision to Scope Package 22.01 Underslab Mechanical and Plumbing**
  - a. CM Clarification #007 Post Bid – Bid Form

Please Contact **Tina Jones, Buyer IV** with any questions:

Tina Jones

(918) 384-7802

[Tina.Jones@cnet.com](mailto:Tina.Jones@cnet.com)

- END OF CM CLARIFICATION -

# FOREMAN | MANHATTAN Construction Team

RFI #001

Foreman | Manhattan Construction Team  
5601 South 122nd East Avenue  
Tulsa, Oklahoma 74146  
Phone: (918) 583-6900  
Fax: (918) 592-4334

Project: 3882 - Tahlequah Cherokee Casino  
3307 S. Seven Clans Ave.  
Tahlequah, Oklahoma 74464

## Underslab Waste and Grease Waste Piping

<b>TO:</b>	Gary Moore (Childers)	<b>FROM:</b>	Dalton Fanning (Manhattan - Tulsa) 5601 South 122nd East Avenue Tulsa, Oklahoma 74146
<b>DATE INITIATED:</b>	04/12/ 2018	<b>STATUS:</b>	Closed
<b>LOCATION:</b>		<b>DUE DATE:</b>	04/16/2018
<b>COST CODE:</b>		<b>REFERENCE:</b>	
<b>COST IMPACT:</b>	Yes (Unknown)	<b>SCHEDULE IMPACT:</b>	Yes (Unknown)
<b>DRAWING NUMBER:</b>	PU0.0	<b>SPEC SECTION:</b>	22 1316 - SANITARY WASTE AND VENT PIPING

**LINKED DRAWINGS:** [PU0.0](#)

**RECEIVED FROM:**

**COPIES TO:**

James Carter (CNE/CNB), Dalton Fanning (Manhattan - Tulsa), Patrick Fogarty (Manhattan - Tulsa), Chris Griffin (Manhattan - Tulsa), Chad Stabers (Manhattan - Tulsa), Luke Wilson (Manhattan - Tulsa)

### Question from Dalton Fanning (Manhattan - Tulsa) at 02:47 PM on 04/12/2018

Per sheet PU0.0 underslab Domestic Waste & Vent Piping materials shall be No-Hub Cast Iron or PVC/ABS based on soil conditions. Please verify if soil conditions are acceptable to use PVC/ABS in lieu of cast iron.

Regarding Grease Waste piping, please verify if grease waste piping to be heat traced and insulated?

**Official Response:** Gary Moore (Childers) responded on Monday, April 16th, 2018 at 11:28AM CDT

All underground piping can be PVC/ABS, Except grease waste shall be stainless steel and shall be heat traced.

See attached heat traced spec

Robbie Jones

MSA Engineering

4-15-2018

**Attachments:**

[Heat Traced Spec.pdf](#)

Coordinate and/or incorporate the enclosed clarifications to the Contract Documents as described in this RFI. Proceed with the clarifications described herein unless there is a cost or time impact to your work. If this RFI constitutes a change in cost or contract time to your scope, provide written notification of change to Manhattan within 48 hours of receipt of this RFI.



## XL-Trace System

---

*This step-by-step design guide provides the tools necessary to design a Raychem XL-Trace pipe freeze protection or flow maintenance system. For other applications or for design assistance, contact your Tyco Thermal Controls representative or phone Tyco Thermal Controls at (800) 545-6258. Also, visit our web site at [www.tycothermal.com](http://www.tycothermal.com).*

---

### Contents

Introduction . . . . .	1
How to Use this Guide . . . . .	2
Safety Guidelines . . . . .	2
Warranty . . . . .	3
System Overview . . . . .	3
XL-Trace Applications . . . . .	3
Self-Regulating Heating Cable Construction . . . . .	4
Pipe Freeze Protection Applications . . . . .	5
Typical Pipe Freeze Protection System . . . . .	5
General Water Piping . . . . .	6
Fire Sprinkler Systems . . . . .	8
Flow Maintenance Applications . . . . .	9
Typical Flow Maintenance System . . . . .	9
Greasy Waste Lines . . . . .	10
Fuel Lines . . . . .	12
Pipe Freeze Protection and Flow Maintenance Design . . . . .	13
Design Step by Step . . . . .	13
Step 1 Determine design conditions and pipe heat loss . . . . .	13
Step 2 Select the heating cable . . . . .	18
Step 3 Determine the heating cable length . . . . .	20
Step 4 Determine the electrical parameters . . . . .	22
Step 5 Select the connection kits and accessories . . . . .	26
Step 6 Select the control system . . . . .	31
Step 7 Select the power distribution . . . . .	33
Step 8 Complete the Bill of Materials . . . . .	36
XL-Trace System Pipe Freeze Protection and Flow Maintenance Design Worksheet . . . . .	37

## Introduction

Raychem XL-Trace is designed for pipe freeze protection and flow maintenance in the following applications:

- Freeze protection of general water piping (aboveground and buried)
- Freeze protection of fire sprinkler systems (aboveground and buried supply pipes)
- Flow waste lines (aboveground and buried)
- Flow maintenance of fuel lines (aboveground)

This guide does **not** cover applications in which any of the following conditions exist:

- Hazardous locations, as defined in the national electrical codes
- Pipe temperature other than specified in Table 1 on page 3
- Pipe maintenance temperatures above 150°F (65°C)
- Supply voltage other than 120 V or 208–277 V

If your application conditions are different, or if you have any questions, contact your Tyco Thermal Controls representative or contact Tyco Thermal Controls directly at (800) 545-6258.

---

### How to Use this Guide

This design guide presents Tyco Thermal Controls' recommendations for designing an XL-Trace pipe freeze protection or flow maintenance system. It provides design and performance data, electrical sizing information, and application configuration suggestions. Following these recommendations will result in a reliable, energy-efficient system.

#### OTHER REQUIRED DOCUMENTS

This guide is not intended to provide comprehensive installation instructions. For complete XL-Trace pipe freeze protection and flow maintenance system installation instructions, please refer to the following additional required documents:

- *XL-Trace System Installation and Operation Manual* (H58033)
- Additional installation instructions are included with the connection kits, thermostats, controllers, and accessories

If you do not have these documents, you can obtain them from the Tyco Thermal Controls web site at [www.tycothermal.com](http://www.tycothermal.com).

For products and applications not covered by this design guide, please contact your Tyco Thermal Controls representative or call Tyco Thermal Controls directly at (800) 545-6258.

---

### Safety Guidelines

As with any electrical equipment, the safety and reliability of any system depends on the quality of the products selected and the manner in which they are installed and maintained. Incorrect design, handling, installation, or maintenance of any of the system connection kits could damage the system and may result in inadequate performance, overheating, electric shock, or fire. To minimize these risks and to ensure that the system performs reliably, read and carefully follow the information, warnings, and instructions in this guide.



This symbol identifies important instructions or information.



This symbol identifies particularly important safety warnings that must be followed.



**WARNING:** To minimize the danger of fire from sustained electrical arcing if the heating cable is damaged or improperly installed, and to comply with the requirements of Tyco Thermal Controls, agency certifications, and national electrical codes, ground-fault equipment protection must be used on each heating cable branch circuit. Arcing may not be stopped by conventional circuit protection.

## Warranty

Tyco Thermal Controls' standard limited warranty applies to all products.



An extension of the limited warranty period to ten (10) years from the date of installation is available if a properly completed online warranty form is submitted within thirty (30) days from the date of installation. You can access the complete warranty on our web site at [www.tycothermal.com](http://www.tycothermal.com).

## System Overview

The XL-Trace system provides freeze protection and flow maintenance for aboveground and buried pipe applications. The XL-Trace system is based on self-regulating heating cable technology. Tyco Thermal Controls offers the option of three self-regulating heating cables with the XL-Trace system: 5XL, 8XL, and 12XL (208–277 V only) for applications using 120 and 208–277 V power supplies. The cable's output is reduced automatically as the pipe warms, so there is no possibility of failure due to overheating.

An XL-Trace system includes the heating cable, power connection, splice, tee connections, controls, contactors, power distribution panels, accessories, and the tools necessary for a complete installation.

## XL-Trace Applications

Identify which of the standard XL-Trace applications below pertain to your installation. Proceed to the appropriate design sections that follow.

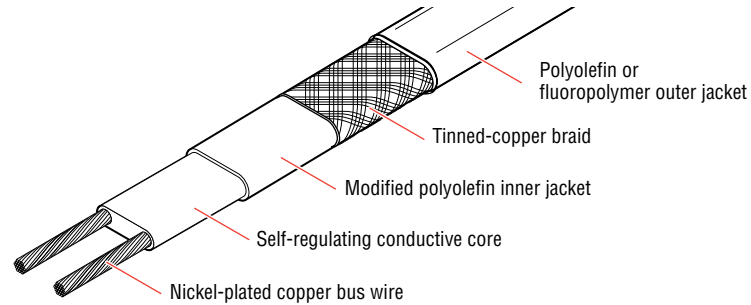
**Table 1 XL-Trace Applications**

Application	Description	Specific application requirements
<b>Pipe freeze protection</b>		
General water piping	Freeze protection (40°F [4°C] minimum) of insulated, metal or plastic water piping	"Aboveground piping," page 6 "Buried piping," page 7
Sprinkler piping	Freeze protection (40°F [4°C] minimum) of standpipes up to 20", supply pipes and branch lines with sprinklers	"Standpipes, supply pipes, and branch lines with sprinklers" on page 8. Also see " <i>XL-Trace System for Fire Sprinkler Freeze Protection Design Guide</i> " (H58489).
<b>Flow maintenance</b>		
Greasy waste lines	Flow maintenance (110°F [43°C] minimum) for insulated greasy waste lines	"Aboveground piping" on page 10 "Buried piping" on page 11
Fuel lines	Flow maintenance (40°F [4°C] minimum) for insulated metal piping containing #2 fuel oil	"For aboveground piping only," page 12

**Note:** If your application does not fit these guidelines, contact your local Tyco Thermal Controls representative or call (800) 545-6258.

### Self-Regulating Heating Cable Construction

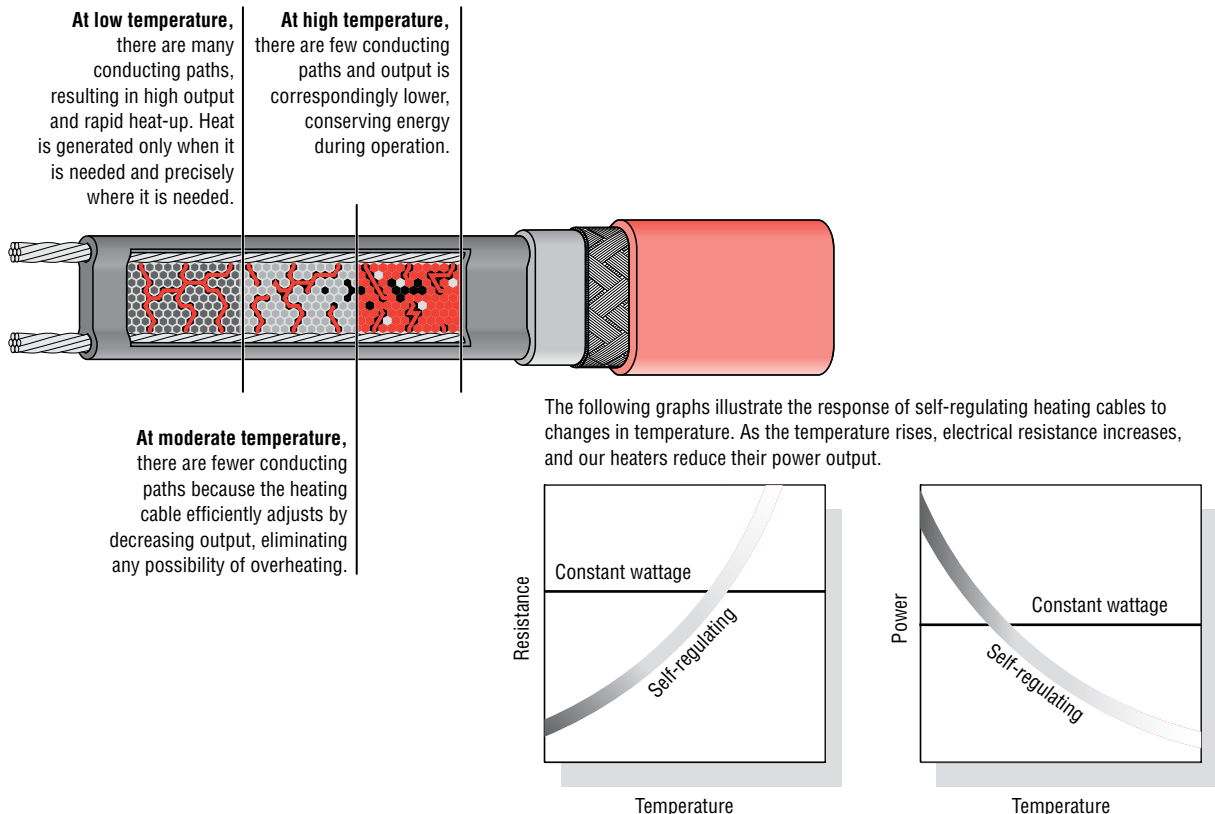
Raychem XL-Trace self-regulating heating cables are comprised of two parallel nickel-coated bus wires in a cross-linked polymer core, a tinned copper braid, and a fluoropolymer or polyolefin outer jacket. These cables are cut to length, simplifying the application design and installation.



**Fig. 1 XL-Trace heating cable construction**

With self-regulating technology, the number of electrical paths between bus wires changes in response to temperature fluctuations. As the temperature surrounding the heater decreases, the conductive core contracts microscopically. This contraction decreases electrical resistance and creates numerous electrical paths between the bus wires. Current flows across these paths to warm the core.

As the temperature rises, the core expands microscopically. This expansion increases electrical resistance and the number of electrical paths decreases. The heating cable automatically reduces its output.



**Fig. 2 Self-regulating heating cable technology**

## Pipe Freeze Protection Applications

A pipe freeze protection system is designed to maintain water temperature at a minimum of 40°F (4°C) to prevent freezing.

### Typical Pipe Freeze Protection System

A typical pipe freeze protection system includes the XL-Trace self-regulating heating cables, connection kits, ambient temperature control, and power distribution.

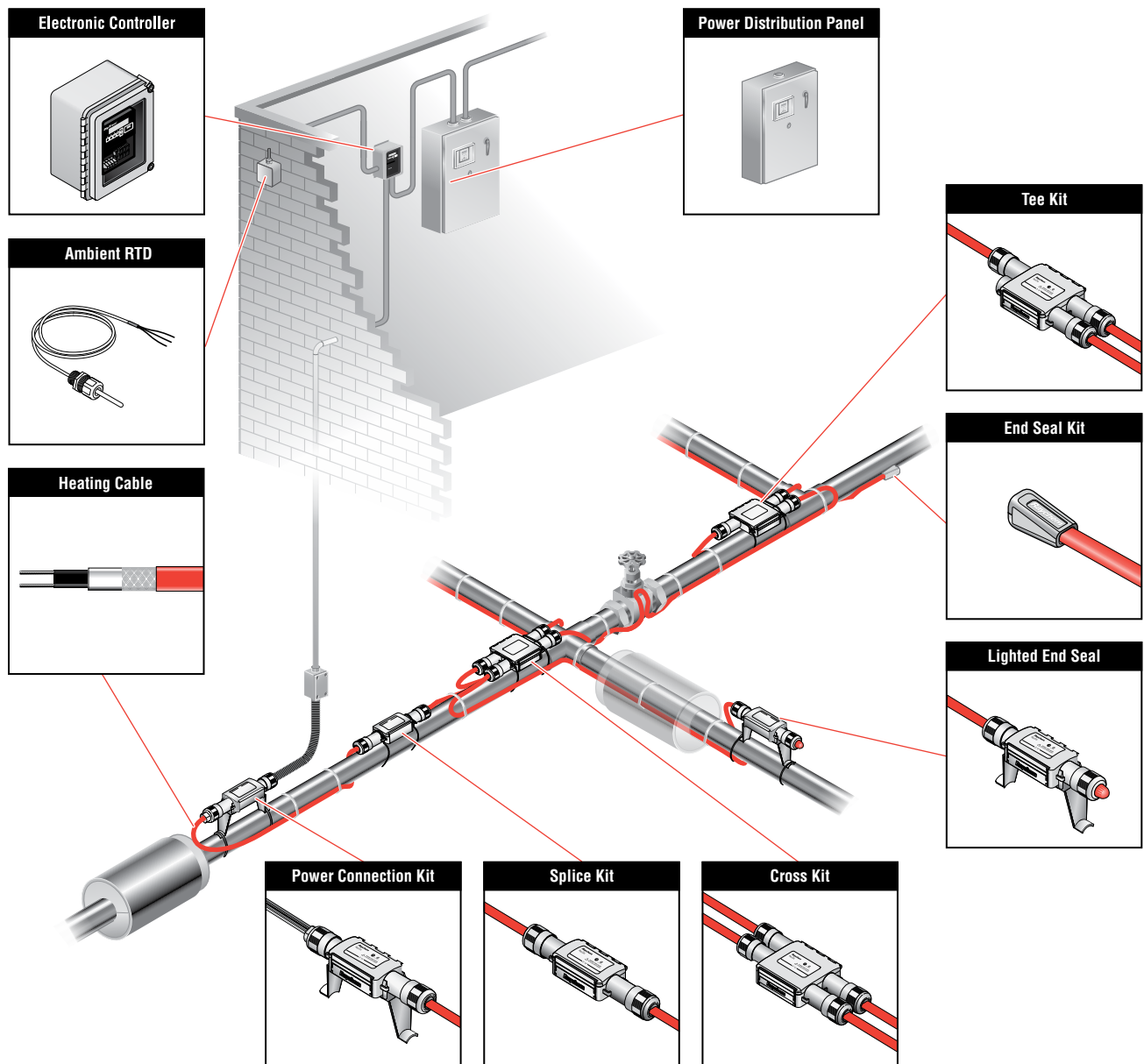
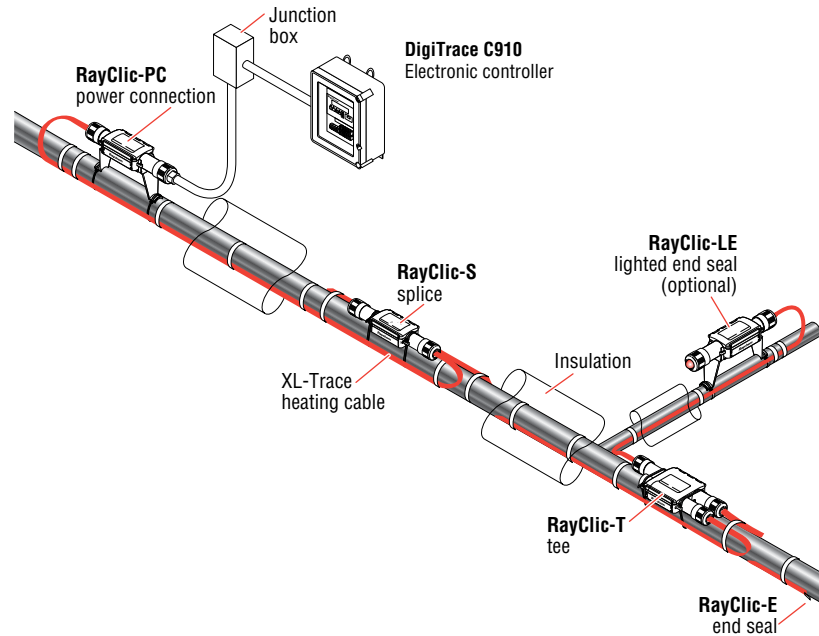


Fig. 3 Typical XL-Trace pipe freeze protection system

**General Water Piping**

General water piping is defined as metal or plastic water piping located in nonhazardous locations.

**ABOVEGROUND PIPING**



**Fig. 4 Typical aboveground piping system**

**Application Requirements**

The system complies with Tyco Thermal Controls requirements for aboveground general water piping when:

- The heating cable is permanently secured to insulated metal pipes with GT-66 glass tape, or to plastic pipes using AT-180 aluminum tape.
- A 30-mA ground-fault protection device (GFPD) is used.
- The heating cable is installed per manufacturer’s instructions with approved Raychem connection kits. See Table 13 on page 27 and the *XL-Trace System Installation and Operation Manual* (H58033).

**Cable Selection**

See “Other Required Documents” page 14.

**Approvals**

UL Listed, FM Approved, and c-CSA-us Certified for nonhazardous locations.



5XL1-CR, -CT  
5XL2-CR, -CT

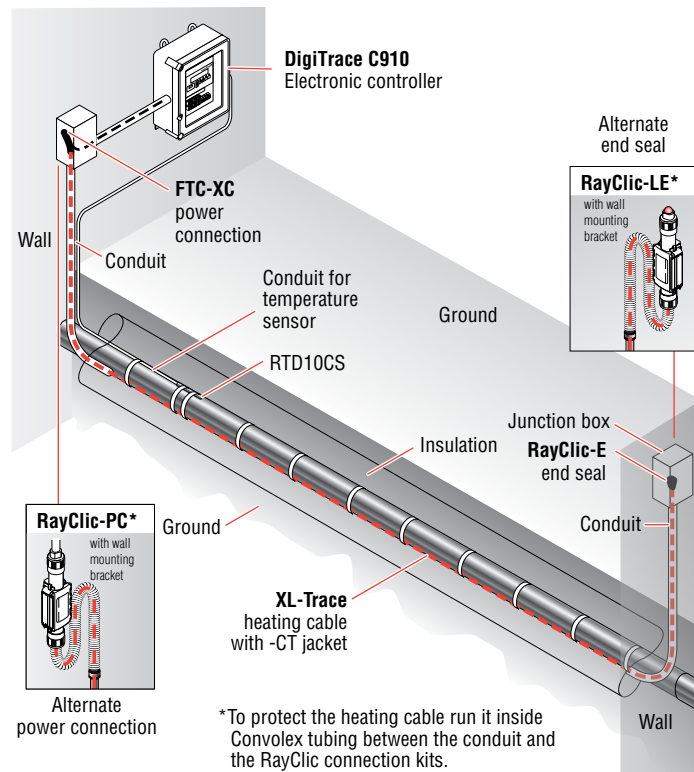
8XL1-CR, -CT  
8XL2-CR, -CT

5XL1-CR, -CT  
5XL2-CR, -CT

8XL1-CR, -CT  
8XL2-CR, -CT

12XL2-CR, -CT



**BURIED PIPING****Fig. 5 Typical buried piping system****Application Requirements**

The system complies with Tyco Thermal Controls requirements for use on buried insulated metal or plastic pipe when:

- The pipeline is buried at least 2 feet deep.
- All heating cable connections (power, splice, tee, and end termination) are made above-ground. No buried or in-conduit splices or tees are allowed.
- The heating cable has a fluoropolymer outer jacket (-CT).
- The power connection and end seal are made in UL Listed and CSA Certified junction boxes above grade.
- The heating cable is protected from the pipe to the power connection box in UL Listed and CSA Certified water-sealed conduit (minimum 3/4-inch diameter) suitable for the location.
- A 30-mA ground-fault protection device (GFPD) is used.
- Closed-cell, waterproof thermal insulation with fire-retardant, waterproof covering is used.
- The heating cable is installed per manufacturer's instructions with approved Tyco Thermal Controls connection kits. See Table 15 on page 29 and the *XL-Trace System Installation and Operation Manual* (H58033).

**Cable Selection**

See "Pipe Heat Loss Calculations," page 14.

**Approvals**

UL Listed, FM Approved, and c-CSA-us Certified for nonhazardous locations.



5XL1-CT  
5XL2-CT



8XL1-CT  
8XL2-CT



5XL1-CT  
5XL2-CT

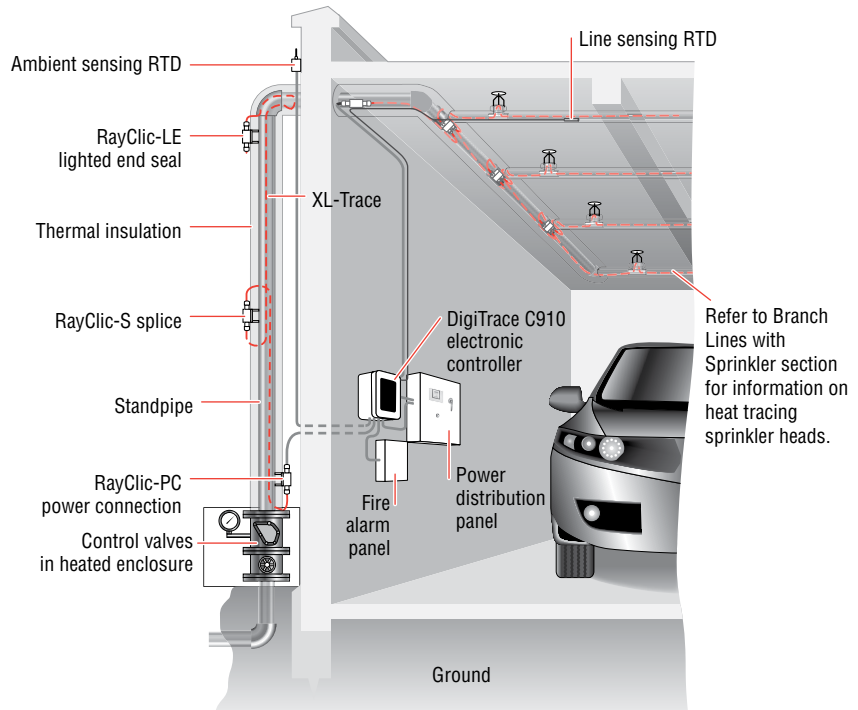
8XL1-CT  
8XL2-CT

12XL2-CT

**Fire Sprinkler Systems**

XL-Trace is designed to maintain fire suppression system standpipes, supply piping, mains, feeders, branch lines and sprinklers at 40°F (4°C) in areas subject to freezing.

**STANDPIPES, SUPPLY PIPES, AND BRANCH LINES WITH SPRINKLERS**



**Fig. 6 Standard sprinkler standpipe heating system layout**

Refer to the *Fire Sprinkler System Freeze Protection Design Guide* (H58489) for detailed instructions to design XL-Trace heating cable circuits to freeze protect aboveground or buried supply pipe, feeders, mains standpipes, branch lines and sprinklers.

**Approvals**

The 2007 edition of NFPA 13 (Standard for the Installation of Sprinkler Systems) allows Listed electrical heat tracing to freeze protect fire suppression systems including supply lines, standpipes and branch lines containing sprinklers. XL-Trace is c-CSA-us Certified for use on fire suppression systems under CSA C22.2 No. 130-03 for Canada and IEEE 515.1-2005 for the US. The system covered in this manual includes supply lines, standpipes, branch lines and sprinkler heads.

XL-Trace systems are also UL and ULC Listed for freeze-protecting sprinkler supply lines, standpipes up to 20 inches in diameter and branch lines not containing sprinklers.



5XL1-CR, -CT  
5XL2-CR, -CT



8XL1-CR, -CT  
8XL2-CR, -CT



5XL1-CR, -CT  
5XL2-CR, -CT

12XL2-CR, -CT (not for branch lines with sprinklers and sprinkler heads)

## Flow Maintenance Applications

A flow maintenance system is designed to maintain cooking greasy waste lines and #2 fuel oil lines above the temperature at which the viscosity inhibits fluid flow.

### Typical Flow Maintenance System

A typical flow maintenance system includes the XL-Trace self-regulating heating cables with a fluoropolymer outer jacket, connection kits, line-sensing temperature control and power distribution.

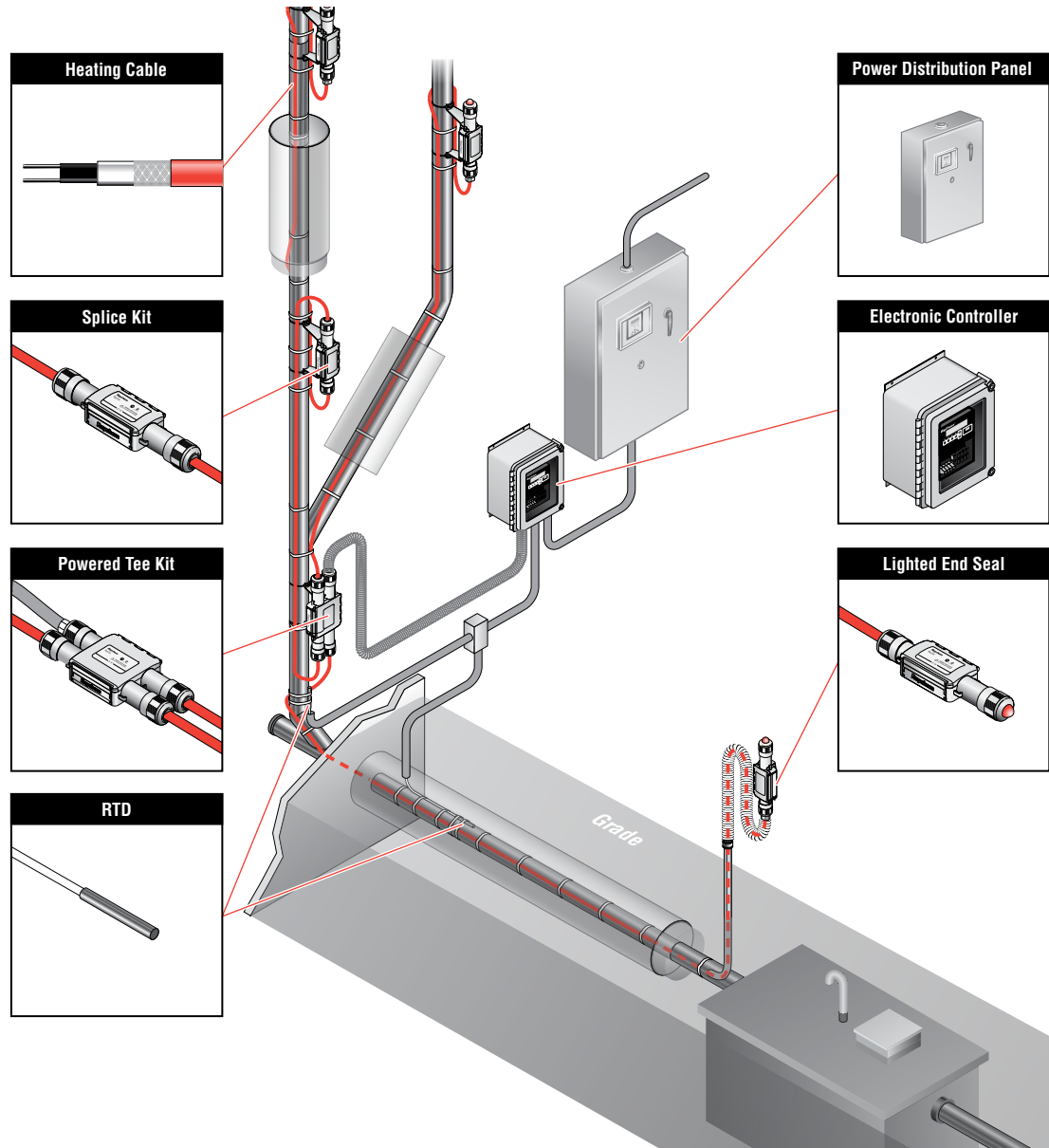
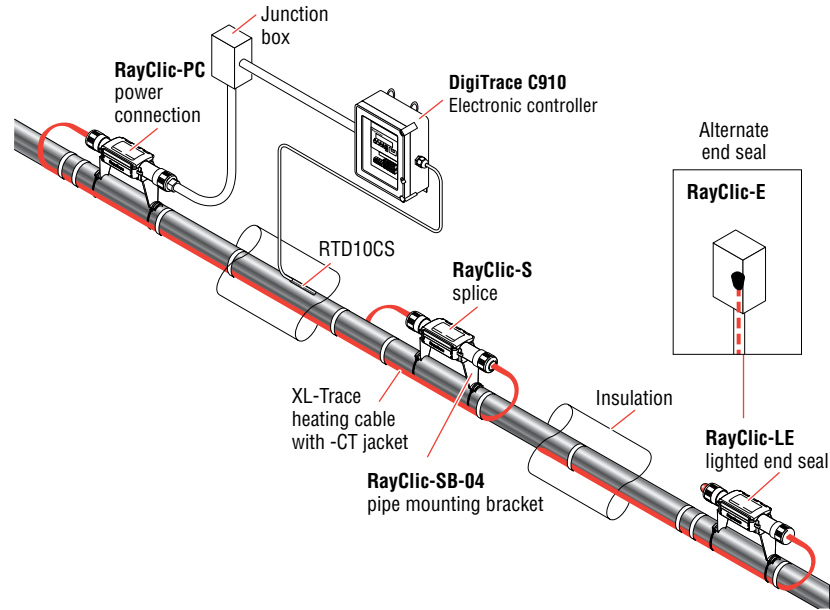


Fig. 7 Typical XL-Trace flow maintenance system

**Greasy Waste Lines**

Greasy waste lines are defined as piping used for the disposal of waste oils and fats created in the cooking process. Typical applications include greasy waste lines from commercial restaurants. A grease-line flow maintenance system is designed to maintain a 110°F (43°C) minimum fluid temperature.

**ABOVEGROUND PIPING**



**Fig. 8 Typical aboveground piping system**

**Application Requirements**

The system complies with Tyco Thermal Controls requirements for aboveground greasy waste lines when:

- The heating cable is permanently secured to metal pipes with GT-66 glass tape, or to plastic pipes using AT-180 aluminum tape.
- The heating cable must have a fluoropolymer outer jacket (-CT).
- A 30-mA ground-fault protection device (GFPD) is used.
- Tees and splices are installed using pipe mounting brackets, not in direct contact with piping.
- The heating cable is installed per manufacturer's instructions with approved Tyco Thermal Controls connection kits. See Table 13 on page 27 and the *XL-Trace System Installation and Operation Manual* (H58033).

**Cable Selection**

See "Pipe Heat Loss Calculations," page 14.

**Approvals**

XL-Trace systems (-CT only) are UL Listed, FM Approved, and c-CSA-us Certified for nonhazardous locations.



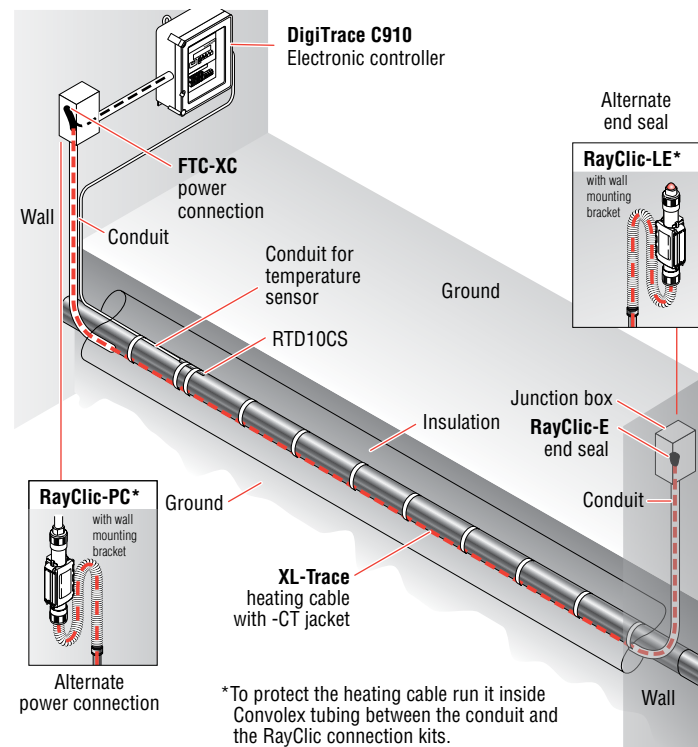
5XL1-CT  
5XL2-CT



8XL1-CT  
8XL2-CT



5XL1-CT    8XL1-CT    12XL2-CT  
5XL2-CT    8XL2-CT

**BURIED PIPING****Fig. 9 Typical buried greasy waste line****Application Requirements**

The system complies with Tyco Thermal Controls requirements for buried greasy waste lines when:

- The heating cable is permanently secured to metal pipes with GT-66 glass tape, or to plastic pipes using AT-180 aluminum tape.
- The heating cable must have a fluoropolymer outer jacket (-CT).
- The pipeline is buried at least 2 feet deep.
- All heating cable splices or tees are made aboveground. No buried or in-conduit splices or tees are allowed.
- The power connection and end seal are made in UL Listed and CSA Certified junction boxes above grade.
- The heating cable is protected from the pipe to the power connection box in UL Listed and CSA Certified conduit (minimum 3/4-inch diameter) suitable for the location.
- A 30-mA ground-fault protection device (GFPD) is used.
- Closed-cell, waterproof thermal insulation with fire-retardant, waterproof covering is used.
- The heating cable is installed per manufacturer's instructions with approved Tyco Thermal Controls connection kits. See Table 15 on page 29 and the *XL-Trace System Installation and Operation Manual* (H58033).

**Cable Selection**

See "Heating Cable Catalog Number" on page 18.

**Approvals**

XL-Trace systems (-CT only) are UL Listed, FM Approved, and c-CSA-us Certified for nonhazardous locations.



5XL1-CT  
5XL2-CT



8XL1-CT  
8XL2-CT



5XL1-CT  
5XL2-CT

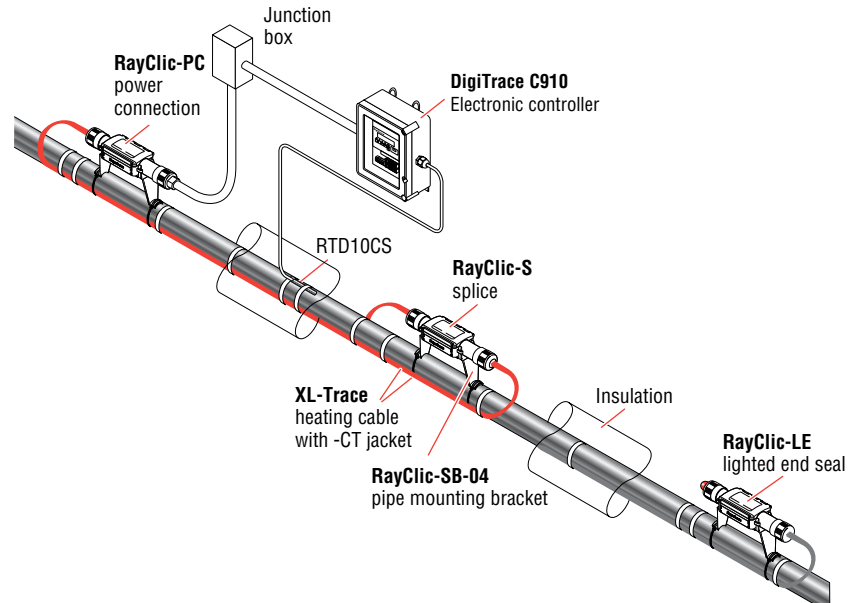
8XL1-CT  
8XL2-CT

12XL2-CT

**Fuel Lines**

Fuel lines are defined as those carrying #2 fuel oil. A fuel line flow maintenance system is designed to maintain a 40°F (4°C) minimum fluid temperature to maintain flow.

**FOR ABOVEGROUND PIPING ONLY**



**Fig. 10 Typical aboveground piping system**

**Application Requirements**

The system complies with Tyco Thermal Controls requirements for aboveground #2 fuel oil piping when:

- The heating cable is permanently secured to metal pipes with GT-66 glass tape, or to plastic pipes using AT-180 aluminum tape.
- The heating cable must have a fluoropolymer outer jacket (-CT).
- Tees and splices are installed using pipe mounting brackets, not in direct contact with piping.
- A 30-mA ground-fault protection device (GFPD) is used.
- The heating cable is installed per manufacturer’s instructions with approved Tyco Thermal Controls connection kits. See Table 13 on page 27 and the *XL-Trace System Installation and Operation Manual* (H58033).

**Cable Selection**

See “Pipe Heat Loss Calculations,” page 14.

**Approvals**

XL-Trace systems (-CT only) are UL Listed, FM Approved, and c-CSA-us Certified for nonhazardous locations.



5XL1-CT  
5XL2-CT



8XL1-CT  
8XL2-CT



5XL1-CT 8XL1-CT 12XL2-CT  
5XL2-CT 8XL2-CT

## Pipe Freeze Protection and Flow Maintenance Design

This section details the design steps necessary to design your application. The examples provided in each step are intended to incrementally illustrate the project parameter output for two sample designs from start to finish. As you go through each step, use the “XL-Trace System Pipe Freeze Protection and Flow Maintenance Design Worksheet,” page 37, to document your project parameters, so that by the end of this section you will have the information you need for your Bill of Materials.



XL-Erate, the commercial pipe freeze protection and flow maintenance design software is available at <http://www.tycothermal.com> to assist with your design.

### Design Step by Step

Your system design requires the following essential steps.

- 1 Determine design conditions and pipe heat loss
- 2 Select the heating cable
- 3 Determine the heating cable length
- 4 Determine the electrical parameters
- 5 Select the connection kits and accessories
- 6 Select the control system
- 7 Select the power distribution
- 8 Complete the Bill of Materials

Pipe Freeze Protection and Flow Maintenance
1. Determine design conditions and heat loss
2. Select the heating cable
3. Determine the heating cable length
4. Determine the electrical parameters
5. Select the connection kits and accessories
6. Select the control system
7. Select the power distribution
8. Complete the Bill of Materials

#### Step 1 Determine design conditions and pipe heat loss

Collect the following information to determine your design conditions:

- XL-Trace application (*from Table 1* Location)
  - Indoors
  - Outdoors
  - Aboveground
  - Buried
- Maintain temperature ( $T_M$ )
- Maximum system temperature ( $T_{MAX}$ )
- Minimum ambient temperature ( $T_A$ )
- Pipe diameter and material
- Pipe length
- Thermal insulation type and thickness
- Supply voltage

#### Example: Pipe Freeze Protection – Water Piping

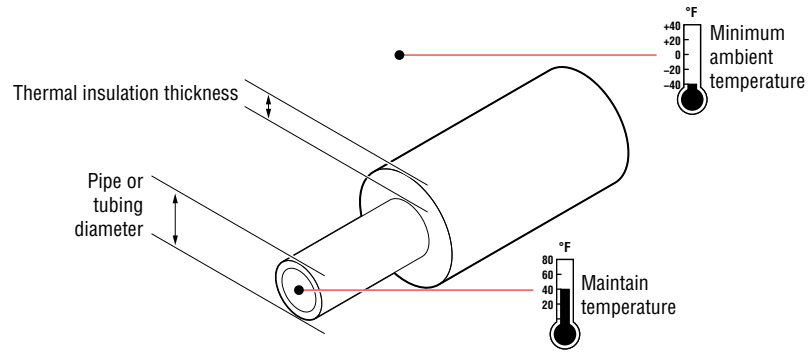
Location	Aboveground, outdoor
Maintain temperature ( $T_M$ )	40°F (4°C)
Maximum system temperature ( $T_{MAX}$ )	80°F (27°C)
Minimum ambient temperature ( $T_A$ )	-20°F (-29°C)
Pipe diameter and material	2-inch plastic
Pipe length	300 ft (91 m)
Thermal insulation type and thickness	1-inch fiberglass
Supply voltage	120 V

**Example: Pipe Freeze Protection – Greasy Waste Line**

Location	Buried
Maintain temperature (T <sub>M</sub> )	110°F (43°C)
Maximum system temperature (T <sub>MAX</sub> )	125°F (52°C)
Minimum ambient temperature (T <sub>A</sub> )	50°F (10°C) (soil temperature)
Pipe diameter and material	4-inch metal
Pipe length	200 ft (61 m)
Thermal insulation type and thickness	1-inch rigid cellular urethane
Supply voltage	208 V

**PIPE HEAT LOSS CALCULATIONS**

To select the proper heating cable you must first determine the pipe heat loss. To do this you must first calculate the temperature differential (ΔT) between the pipe maintain temperature and the minimum ambient temperature.



**Fig. 11 Pipe heat loss**

**Calculate temperature differential ΔT**

To calculate the temperature differential (ΔT), use the formula below:

$$\Delta T = T_M - T_A$$

**Example: Pipe Freeze Protection – Water Piping**

T <sub>M</sub>	40°F (4°C)
T <sub>A</sub>	-20°F (-29°C)
	<b>ΔT = 40°F - (-20°F) = 60°F</b>
	<b>ΔT = 4°C - (-29°C) = 33°C</b>

**Example: Flow Maintenance – Greasy Waste Line**

T <sub>M</sub>	110°F (43°C)
T <sub>A</sub>	50°F (10°C)
	<b>ΔT = 110°F - (50°F) = 60°F</b>
	<b>ΔT = 43°C - (10°C) = 33°C</b>

**Determine the pipe heat loss**

Match the pipe size, insulation thickness, and temperature differential (ΔT) from Table 2 to determine the base heat loss of the pipe (Q<sub>B</sub>).

**Example: Pipe Freeze Protection – Water Piping**

Pipe diameter	2 inch
---------------	--------



Insulation thickness 1 inch  
 $\Delta T$  60°F (33°C)

Heat loss ( $Q_B$ ) for 60°F must be calculated through interpolation between  $\Delta T$  at 50°F and  $\Delta T$  at 100°F from Table 2. For difference between the  $\Delta T$  of 50°F and the  $\Delta T$  of 100°F:

$Q_{B-50}$  3.2 W/ft (from Table 2)  
 $Q_{B-100}$  6.8 W/ft (from Table 2)  
 $\Delta T$  interpolation  $\Delta T$  60°F is 20% of the distance between  $\Delta T$  50°F and  $\Delta T$  100°F  
 $Q_{B-60}$   $Q_{B-50} + [0.20 \times (Q_{B-100} - Q_{B-50})] = 3.2 + [0.20 \times (6.8 - 3.2)] = 3.9$  W/ft  
 Pipe heat loss ( $Q_B$ ) **3.9 W/ft @  $T_M$  40°F (12.9 W/m @  $T_M$  4°C)**

**Example: Flow Maintenance – Greasy Waste Line**

Pipe diameter 4 inch  
 Insulation thickness 1 inch  
 $\Delta T$  60°F (33°C)

$Q_B$  for 60°F must be calculated through interpolation between  $\Delta T$  at 50°F and  $\Delta T$  at 100°F from Table 2. For difference between the  $\Delta T$  of 50°F and the  $\Delta T$  of 100°F:

$Q_{B-50}$  5.4 W/ft (from Table 2)  
 $Q_{B-100}$  11.2 W/ft (from Table 2)  
 $\Delta T$  interpolation  $\Delta T$  60°F is 20% of the distance between  $\Delta T$  50°F and  $\Delta T$  100°F  
 $Q_{B-60}$   $Q_{B-50} + [0.20 \times (Q_{B-100} - Q_{B-50})] = 5.4 + [0.20 \times (11.2 - 5.4)] = 6.6$  W/ft  
 Pipe heat loss  $Q_B$  **6.6 W/ft @  $T_M$  110°F (21.5 W/m @  $T_M$  43°C)**

**Compensate for insulation type and pipe location**

The base heat loss is calculated for a pipe insulated with thermal insulation with a k-factor ranging from 0.2 to 0.3 BTU/hr-°F-ft<sup>2</sup>/in (fiberglass or foamed elastomer) in an outdoor, or buried application. To get the heat loss for pipes insulated with alternate types of thermal insulation and for pipes installed indoors, multiply the base heat loss of the pipe ( $Q_B$ ) from Step 3 by the insulation multiple from Table 4 and the indoor multiple from Table 3 to get the corrected heat loss:

$$Q_{CORRECTED} = Q_B \times \text{Insulation multiple} \times \text{Indoor multiple}$$

**Example: Pipe Freeze Protection – Water Piping**

Location Aboveground, outdoor  
 Thermal insulation thickness and type 1-inch fiberglass  
 Pipe heat loss  $Q_B$  3.9 W/ft @  $T_M$  40°F (12.9 W/m @  $T_M$  4°C)  
 $Q_{CORRECTED}$   $3.9 \text{ W/ft} \times 1.00 \times 1.00 = 3.9 \text{ W/ft @ } T_M 40^\circ\text{F}$   
**(12.9 W/m @  $T_M$  4°C)**

**Example: Flow Maintenance – Greasy Waste Line**

Location Buried  
 Thermal insulation type and thickness 1-inch rigid cellular urethane  
 Pipe heat loss  $Q_B =$  6.6 W/ft @  $T_M$  110°F (21.5 W/m @  $T_M$  43°C)  
 $Q_{CORRECTED} =$   $6.6 \text{ W/ft} \times 0.6 \times 1.00 = 4.0 \text{ W/ft @ } T_M 110^\circ\text{F}$   
**(13.1 W/m @  $T_M$  43°C)**

**Table 2 Pipe Heat Loss (Q<sub>p</sub>) for Outdoor or Buried Pipe (W/ft) for 1/2 to 3-1/2 inches**

Insulation thickness (in)	(ΔT)		Pipe diameter (IPS) in inches								
	°F	°C	1/2	3/4	1	1-1/4	1-1/2	2	2-1/2	3	3-1/2
0.5	20	11	1.0	1.2	1.4	1.6	1.8	2.2	2.5	3.0	3.4
	50	28	2.5	2.9	3.5	4.1	4.6	5.5	6.5	7.7	8.6
	100	56	5.2	6.1	7.2	8.6	9.6	11.5	13.5	16.0	18.0
	150	83	8.1	9.5	11.2	13.4	14.9	17.9	21.1	25.0	28.1
1.0	20	11	0.6	0.7	0.8	1.0	1.1	1.3	1.5	1.7	1.9
	50	28	1.6	1.9	2.2	2.5	2.8	3.2	3.8	4.4	4.9
	100	56	3.4	3.9	4.5	5.2	5.8	6.8	7.8	9.1	10.2
	150	83	5.3	6.1	7.0	8.2	9.0	10.6	12.2	14.2	15.9
1.5	20	11	0.5	0.6	0.7	0.8	0.8	1.0	1.1	1.3	1.4
	50	28	1.3	1.5	1.7	1.9	2.1	2.4	2.8	3.2	3.6
	100	56	2.8	3.1	3.5	4.0	4.4	5.1	5.8	6.7	7.4
	150	83	4.3	4.8	5.5	6.3	6.9	8.0	9.1	10.5	11.6
2.0	20	11	0.5	0.5	0.6	0.6	0.7	0.8	0.9	1.0	1.1
	50	28	1.1	1.3	1.4	1.6	1.8	2.0	2.3	2.6	2.9
	100	56	2.4	2.7	3.0	3.4	3.7	4.2	4.8	5.5	6.0
	150	83	3.7	4.2	4.7	5.3	5.8	6.6	7.5	8.5	9.4
2.5	20	11	0.4	0.5	0.5	0.6	0.6	0.7	0.8	0.9	1.0
	50	28	1.0	1.2	1.3	1.4	1.6	1.8	2.0	2.3	2.5
	100	56	2.2	2.4	2.7	3.0	3.3	3.7	4.2	4.7	5.2
	150	83	3.4	3.7	4.2	4.7	5.1	5.8	6.5	7.4	8.1
3.0	20	11	0.4	0.4	0.5	0.5	0.6	0.6	0.7	0.8	0.9
	50	28	1.0	1.1	1.2	1.3	1.4	1.6	1.8	2.0	2.2
	100	56	2.0	2.2	2.4	2.7	2.9	3.3	3.7	4.2	4.6
	150	83	3.1	3.4	3.8	4.3	4.6	5.2	5.8	6.6	7.1
4.0	20	11	0.3	0.4	0.4	0.5	0.5	0.5	0.6	0.7	0.7
	50	28	0.9	0.9	1.0	1.1	1.2	1.4	1.5	1.7	1.8
	100	56	1.8	2.0	2.1	2.4	2.5	2.9	3.2	3.5	3.8
	150	83	2.8	3.0	3.4	3.7	4.0	4.4	4.9	5.5	6.0

**Note:** Multiply the W/ft heat loss values by 3.28 for W/m.

**Table 1.2 continued Pipe Heat Loss ( $Q_B$ ) for Outdoor or Buried Pipe (W/ft) for 4 to 20 inches**

Insulation thickness (in)	$(\Delta T)$		Pipe diameter (IPS) in inches									
	°F	°C	4	6	8	10	12	14	16	18	20	
0.5	20	11	3.8	5.3	6.8	8.4	9.9	10.8	12.2	13.7	15.2	
	50	28	9.6	13.6	17.4	21.4	25.2	27.5	31.3	35.0	38.8	
	100	56	20.0	28.4	36.3	44.6	52.5	57.4	65.2	73.0	80.8	
	150	83	31.2	44.3	56.6	69.6	81.9	89.5	101.7	113.8	126.0	
1.0	20	11	2.1	2.9	3.7	4.5	5.3	5.8	6.5	7.3	8.0	
	50	28	5.4	7.5	9.4	11.5	13.5	14.7	16.6	18.6	20.5	
	100	56	11.2	15.6	19.7	24.0	28.1	30.6	34.7	38.7	42.8	
	150	83	17.5	24.3	30.7	37.4	43.8	47.8	54.1	60.4	66.7	
1.5	20	11	1.5	2.1	2.6	3.2	3.7	4.0	4.5	5.0	5.5	
	50	28	3.9	5.3	6.7	8.1	9.4	10.2	11.5	12.9	14.2	
	100	56	8.1	11.1	13.9	16.8	19.6	21.3	24.0	26.8	29.5	
	150	83	12.7	17.3	21.6	26.2	30.5	33.2	37.5	41.8	46.1	
2.0	20	11	1.2	1.7	2.1	2.5	2.9	3.1	3.5	3.9	4.3	
	50	28	3.1	4.2	5.2	6.3	7.3	7.9	8.9	9.9	10.9	
	100	56	6.6	8.8	10.9	13.1	15.2	16.5	18.6	20.7	22.8	
	150	83	10.2	13.8	17.0	20.5	23.8	25.8	29.0	32.3	35.5	
2.5	20	11	1.1	1.4	1.7	2.1	2.4	2.6	2.9	3.2	3.5	
	50	28	2.7	3.6	4.4	5.2	6.1	6.6	7.4	8.2	9.0	
	100	56	5.6	7.4	9.1	10.9	12.6	13.7	15.3	17.0	18.7	
	150	83	8.7	11.6	14.2	17.0	19.7	21.3	23.9	26.5	29.1	
3.0	20	11	0.9	1.2	1.5	1.8	2.0	2.2	2.5	2.7	3.0	
	50	28	2.4	3.1	3.8	4.5	5.2	5.6	6.3	7.0	7.6	
	100	56	4.9	6.5	7.9	9.4	10.8	11.7	13.1	14.5	15.9	
	150	83	7.7	10.1	12.4	14.7	16.9	18.3	20.5	22.6	24.8	
4.0	20	11	0.8	1.0	1.2	1.4	1.6	1.7	1.9	2.1	2.3	
	50	28	2.0	2.5	3.1	3.6	4.1	4.4	5.0	5.5	6.0	
	100	56	4.1	5.3	6.4	7.5	8.6	9.3	10.3	11.4	12.4	
	150	83	6.4	8.3	10.0	11.8	13.4	14.5	16.1	17.8	19.4	

**Note:** Multiply the W/ft heat loss values by 3.28 for W/m.

**Table 3 Indoor Pipe Heat Loss Multiples**

Fiberglass thickness (in)	Indoor multiple
0.5	0.79
1	0.88
1.5	0.91
2	0.93
2.5	0.94
3	0.95
4	0.97

**Table 4 Insulation Heat Loss Multiples**

k factor at 50°F (10°C) (BTU/hr-°F-ft <sup>2</sup> /in)	Insulation multiple	Examples of preformed pipe insulation
0.1–0.2	0.6	Rigid cellular urethane (ASTM C591)
0.2–0.3	1.0	Glass fiber (ASTM C547) Foamed elastomer (ASTM C534)
0.3–0.4	1.4	Cellular glass (ASTM C552) Mineral fiber blanket (ASTM C553)

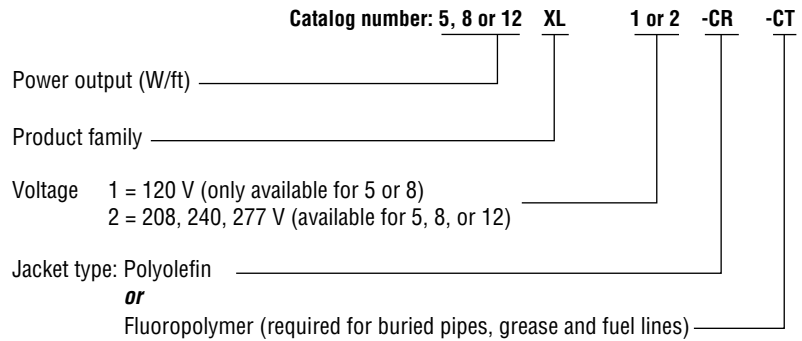
Pipe Freeze Protection and Flow Maintenance
1. Determine design conditions and heat loss
2. Select the heating cable
3. Determine the heating cable length
4. Determine the electrical parameters
5. Select the connection kits and accessories
6. Select the control system
7. Select the power distribution
8. Complete the Bill of Materials

**Step 2 Select the heating cable**

To select the appropriate XL-Trace heating cable for your application, you must determine your cable supply voltage, power output, and outer jacket. Once you select these, you will be able to determine the catalog number for your cable.

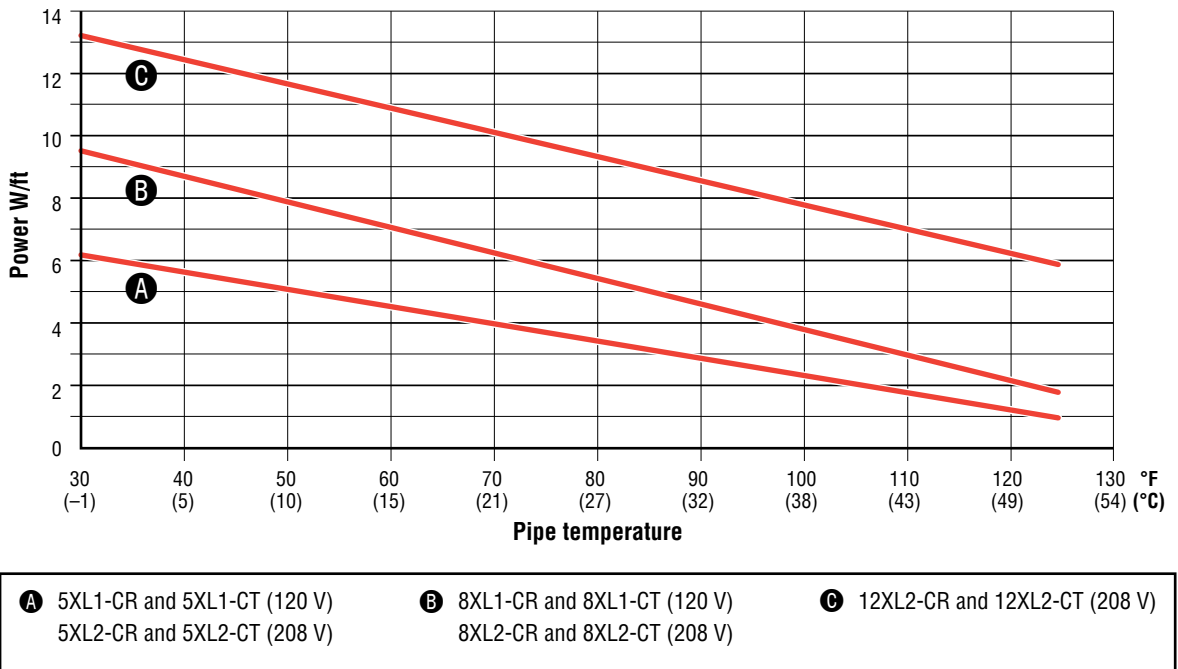
**HEATING CABLE CATALOG NUMBER**

Before beginning, take a moment to understand the structure underlying heating cable catalog numbers. You will refer to this numbering convention throughout the product selection process. Your goal is to determine the catalog number for the product that best suits your needs.



**Fig. 12 Heating cable catalog number**

Select the heating cable from Fig. 13 that provides the required power output to match the corrected heat loss for your application. Fig. 13 shows the power output for the heating cables on metal pipe at 120/208 volts. To correct the power output for other applied voltage or plastic pipes multiply the power output at the desired maintain temperature by the factors listed in Table 5. If the pipe heat loss,  $Q_{CORRECTED}$ , is between the two heating cable power output curves, select the higher-rated heating cable.



**Fig. 13 Heating cable power output on metal pipe**

**Table 5 Power Output Correction Factors**

Voltage correction factors	5XL1	8XL1	5XL2	8XL2	12XL2
120 V	1.00	1.00	–	–	–
208 V	–	–	1.00	1.00	1.00
240 V	–	–	1.12	1.12	1.14
277 V	–	–	1.29	1.27	1.30
<b>Plastic pipe correction factor</b> (With AT-180 Aluminum tape)	0.75	0.75	0.75	0.75	0.75

Confirm that the corrected power output of the heating cable selected is greater than the corrected pipe heat loss ( $Q_{CORRECTED}$ ). If  $Q_{CORRECTED}$  is greater than the power output of the highest-rated heating cable, you can:

- Use two or more heating cables run in parallel
- Use thicker insulation to reduce heat loss
- Use insulation material with a lower k factor to reduce heat loss

**Example: Pipe Freeze Protection – Water Piping**

Pipe maintain temperature ( $T_M$ )	40°F (4°C) (from Step 1)
$Q_{CORRECTED}$	$Q_{CORRECTED} = 3.9 \text{ W/ft @ } T_M 40^\circ\text{F}$ (13.1 W/m @ $T_M 4^\circ\text{C}$ )
Supply voltage	120 V (from Step 1)
Pipe material	Plastic (from Step 1)
Select heating cable:	$Q_b = 3.9 \text{ W/ft @ } T_M 40^\circ\text{F}$ (from Step 1) <b>5XL1 = 5.6 W/ft @ 40°F</b> (from Fig. 13)
Supply voltage correction factor	<b>1.00</b> (from Table 5)
Pipe material correction factor	<b>Plastic = 0.75</b> (from Table 5)
Corrected heating cable power	<b>5.6 W/ft x 1.00 x 0.75 = 4.2 W/ft</b>
Selected heating cable	<b>5XL1</b>

**Example: Flow Maintenance – Greasy Waste Line**

Pipe maintain temperature ( $T_M$ )	110°F (43°C) (from Step 1)
$Q_{CORRECTED}$	3.9 W/ft @ $T_M 110^\circ\text{F}$ (13.1 W/m @ $T_M 43^\circ\text{C}$ )
Supply voltage	208 V (from Step 1)
Pipe material	Metal (from Step 1)
Select heating cable:	$Q_b = 3.9 \text{ W/ft @ } T_M 110^\circ\text{F}$ (from Step 1) <b>12XL2 = 7.0 W/ft @ 110°F</b> (from Fig. 13)
Supply voltage correction factor	<b>1.00</b> (from Table 5)
Pipe material correction factor	<b>Metal = 1.00</b>
Corrected heating cable power	<b>7.0 x 1.00 x 1.00 = 7.0 W/ft</b>
Selected heating cable	<b>12XL2</b>

**CONFIRM EXPOSURE TEMPERATURE RATING FOR THE HEATING CABLE**

Refer to Table 6 to verify that the maximum system temperature does not exceed the exposure temperature of the selected heating cable.

**Table 6 Heating Cable Temperature Ratings**

	5XL1	5XL2	8XL1	8XL2	12XL2
Maximum maintain temperature (T <sub>M</sub> )	150°F (65°C)	150°F (65°C)	150°F (65°C)	150°F (65°C)	150°F (65°C)
Maximum exposure temperature (T <sub>EXP</sub> )	150°F (65°C)	150°F (65°C)	150°F (65°C)	150°F (65°C)	185°F (85°C)

**Example: Pipe Freeze Protection – Water Piping**

Maximum system temperature (T<sub>MAX</sub>) 80°F (27°C) (from Step 1)  
 Selected heating cable 5XL1 (from previous step)  
 Maximum heating cable exposure temperature (T<sub>EXP</sub>) 150°F (65°C) (from Table 6)  
 T<sub>MAX</sub> < T<sub>EXP</sub> **Yes**

**Example: Flow Maintenance - Greasy Waste Line**

Maximum system temperature (T<sub>MAX</sub>) 125°F (52°C) (from Step 1)  
 Selected heating cable 12XL2 (from previous step)  
 Maximum heating cable exposure temperature (T<sub>EXP</sub>) 185°F (85°C) (from Table 6)  
 T<sub>MAX</sub> < T<sub>EXP</sub> **Yes**

**SELECT OUTER JACKET**

Select the appropriate heating cable outer jacket for the application. Jacket options are:

- CR Compatible with most XL-Trace applications
- CT Required for grease and fuel line flow maintenance; may be used in other XL-Trace applications for improved mechanical strength and chemical resistance.

**Example: Pipe Freeze Protection – Water Piping**

Selection: 5XL1-CR

**Example: Flow Maintenance - Greasy Waste Line**

Selection: 12XL2-CT

Pipe Freeze Protection and Flow Maintenance
1. Determine design conditions and heat loss
2. Select the heating cable
3. Determine the heating cable length
4. Determine the electrical parameters
5. Select the connection kits and accessories
6. Select the control system
7. Select the power distribution
8. Complete the Bill of Materials

**Step 3 Determine the heating cable length**

In Step 2 you selected the appropriate heating cable and the number of runs of heating cable required for the pipe. Multiply the length of the pipe by the number of heating cable runs for the heating cable length.

Heating cable length = Pipe length x No. heating cable runs

Additional heating cable will be required for heat sinks and connection kits. Use Table 7 and Table 8 to determine the additional footage required for heat sinks (valves, flanges, and pipe supports). You will determine the additional heating cable for connection kits in Step 5. Round up fractional lengths to ensure heating cable lengths are sufficient.

Total heating cable length required = (Pipe length x No. heating cable runs) + Additional heating cable for heat sinks (valves, pipe supports, and flanges)

**Table 7 Additional Heating Cable for Valves**

Pipe diameter (IPS) (inches)	Heating cable (feet (meters))	
1/2	0.8	(0.24)
3/4	1.3	(0.4)
1	2.0	(0.6)
1-1/4	3.3	(1.1)
1-1/2	4.3	(1.3)
2	4.3	(1.3)
3	4.3	(1.3)
4	4.3	(1.3)
6	5.0	(1.5)
8	5.0	(1.5)
10	5.6	(1.7)
12	5.9	(1.9)
14	7.3	(2.2)
18	9.4	(2.9)
20	10.5	(3.2)

**Table 8 Additional Heating Cable for Pipe Supports and Flanges**

Support	Additional cable
Pipe hangers (insulated)	No additional heating cable
Pipe hangers noninsulated and U-bolt supports	Add 2x pipe diameter
Welded support shoes	Add 3x the length of the shoe
<b>Flanges</b>	Add 2x pipe diameter

**Note:** For applications where more than one heating cable is required per foot of pipe, this correction factor applies for each cable run.

**Example: Pipe Freeze Protection – Water Piping**

Pipe length	300 ft (91 m) (from Step 1)
Pipe diameter	2-inch plastic (from Step 1)
Number of heating cable runs	1 (from Step 2)
Valves	3 gate valves 4.3 ft x 3 gate valves = 12.9 ft (3.9 m)
Pipe supports	5 pipe hangers with U-bolts 2-inch pipe diameter = 2 / 12 = 0.17 ft [0.17 ft pipe diameter x 2] x 5 pipe supports = 1.7 ft (0.5 m)
Flanges	0
Total heating cable for heat sinks	12.9 ft (3.9 m) + 1.7 ft (0.5 m) = 14.6 ft (4.4 m) Rounded up to 15 ft (5 m)
Total heating cable length required	300 ft (91 m) x 1 run + 15 ft = <b>315 ft (96 m) of 5XL1-CR</b> <b>(Note: AT-180 Aluminum tape is required for installing heating cable on plastic pipe.)</b>

**Example: Flow Maintenance – Greasy Waste Line**

Pipe length	200 ft (61 m) (from Step 1)
Pipe diameter	4-inch metal (from Step 1)
Number of heating cable runs	1 (from Step 2)
Valves	2 gate valves [4.3 ft x 2 gate valves] x 1 run = 8.6 ft (2.6 m)
Pipe supports	2 non-insulated hangers 4-inch pipe diameter = 4 /12 = 0.33 ft [(0.33 ft pipe diameter x 2) x 2 pipe supports] x 1 run = 1.3 ft (0.4 m)
Flanges	2 4-inch pipe diameter = 4 /12 = 0.33 ft [(2 x 0.33 ft (pipe diameter)) x 2 flanges] x 1 run = 1.3 ft (0.4 m)
Total heating cable for heat sinks	8.6 ft (2.6 m) + 1.3 ft (0.4 m) + 1.3 ft (0.4 m) = 11.2 ft (2.2 m) Rounded up to 12 ft (3 m)
Total heating cable length required	200 ft x 1 run + 12 ft = <b>212 ft (65 m) of 12XL2-CT</b>

Pipe Freeze Protection and Flow Maintenance
1. Determine design conditions and heat loss
2. Select the heating cable
3. Determine the heating cable length
4. Determine the electrical parameters
5. Select the connection kits and accessories
6. Select the control system
7. Select the power distribution
8. Complete the Bill of Materials

**Step 4 Determine the electrical parameters**

To determine the electrical requirements for your application, you must determine the number of circuits and calculate the transformer load.

**DETERMINE NUMBER OF CIRCUITS**


To determine the number of circuits, you need to know:

- Total heating cable length
- Supply voltage
- Minimum start-up temperature

Use Table 9 to determine the maximum circuit length allowed. If the total heating cable length exceeds the maximum circuit length for the expected start-up temperature, more than one circuit will be required.

$$\text{Number of circuits} = \frac{\text{Heating cable length required}}{\text{Maximum heating cable circuit length}}$$

 **Important:** Select the smallest appropriate ground-fault circuit breaker size.

 **WARNING:** To minimize the danger of fire from sustained electrical arcing if the heating cable is damaged or improperly installed, and to comply with the requirements of Tyco Thermal Controls, agency certifications, and national electrical codes, ground-fault equipment protection must be used on each heating cable branch circuit. Arcing may not be stopped by conventional circuit protection.



**Table 9 Maximum Circuit Length in Feet**

40°F / 110°F Maintain*												
Start-up temperature (°F)	CB size (A)	5XL1		5XL2			8XL2			12XL2		
		120 V	120 V	208 V	240 V	277 V	208 V	240 V	277 V	208 V	240 V	277 V
-20°F	15	101	76	174	178	183	131	138	146	111	114	117
	20	134	101	232	237	245	175	184	194	148	151	156
	30	201	151	349	356	367	262	276	291	223	227	234
	40	270	201	465	474	478	349	368	388	297	303	312
0°F	15	115	86	199	203	209	149	157	166	120	122	126
	20	153	115	265	271	279	199	209	221	160	163	168
	30	230	172	398	406	419	298	314	331	239	244	252
	40	270	210	470	490	530	370/399	390/420	420/443	319	326	336
20°F	15	134	100	232	237	244	173	182	192	126	129	133
	20	178	133	309	315	325	231	243	257	169	172	177
	30	270	200	464	473	488	346	365	385	253	258	266
	40	270	210	470	490	530	370/462	390/486	420/513	340/349	344	355
40°F	15	160	119	278	283	292	206	217	229	142	145	150
	20	214	159	370	378	390	275	290	306	190	194	200
	30	270	210	470	490	530	370/416	390/438	420/462	285	291	300
	40	270	210	470	490	530	370/554	390/584	420/616	340/398	360/406	380/419
50°F (buried)	15	–	–	–	–	–	228	240	254	152	155	160
	20	–	–	–	–	–	304	320	338	203	207	213
	30	–	–	–	–	–	457	481	507	304	310	320
	40	–	–	–	–	–	609	641	676	405	414	427
65°F (indoors grease)	15	–	–	–	–	–	272	286	302	169	172	178
	20	–	–	–	–	–	362	381	402	225	230	237
	30	–	–	–	–	–	543	572	603	338	345	356
	40	–	–	–	–	–	610	660	720	430	460	490

\* When maximum circuit length is listed in:

- black type, the value is for applications with a 40°F maintain
- *red italic* type, the value is for applications with a 110°F maintain

**Table 10 Maximum Circuit Length in Meters**

		4°C / 43°C Maintain*										
Start-up temperature (°C)	CB size (A)	5XL1	8XL1	5XL2			8XL2			12XL2		
		120 V	120 V	208 V	240 V	277 V	208 V	240 V	277 V	208 V	240 V	277 V
-29°C	15	31	23	53	54	56	40	42	44	34	35	36
	20	41	31	71	72	75	53	56	59	45	46	48
	30	61	46	106	108	112	80	84	89	68	69	71
	40	82	61	142	145	149	106	112	118	90	92	95
-18°C	15	35	26	61	62	64	45	48	51	36	37	38
	20	47	35	81	83	85	61	64	67	49	50	51
	30	70	52	121	124	128	91	96	101	73	74	77
	40	82	64	143	149	162	113/122	119/128	128/135	97	99	102
-7°C	15	41	31	71	72	74	53	56	59	39	39	41
	20	54	41	94	96	99	70	74	78	51	52	54
	30	82	61	141	144	149	106	111	117	77	79	81
	40	82	64	143	149	162	113/141	119/148	128/156	104/106	105	108
4°C	15	49	36	85	86	89	63	66	70	43	44	46
	20	65	48	113	115	119	84	88	93	58	59	61
	30	82	64	143	149	162	113/127	119/134	128/141	87	89	91
	40	82	64	143	149	162	113/169	119/178	128/188	104/121	110/124	116/128
10°C (buried grease)	15	-	-	-	-	-	70	73	77	46	47	49
	20	-	-	-	-	-	93	98	103	62	63	65
	30	-	-	-	-	-	139	147	155	93	95	98
	40	-	-	-	-	-	186	195	206	124	126	130
18°C (indoors grease)	15	-	-	-	-	-	83	87	92	52	53	54
	20	-	-	-	-	-	110	116	123	69	70	72
	30	-	-	-	-	-	166	174	184	103	105	108
	40	-	-	-	-	-	186	201	220	131	140	149

- \* When maximum circuit length is listed in:
- black type, the value is for applications with a 4°C maintain
  - *red italic* type, the value is for applications with a 43°C maintain

**Example: Pipe Freeze Protection – Water Piping**

Total heating cable length      315 ft of 5XL1-CR (from Step 3)  
 Supply voltage                      120 V (from Step 1)  
 Minimum start-up temperature    -20°F (-29°C) (from Step 1)  
 Number of circuits                  315 ft / (210 ft max CL) = 1.8 circuits  
**Round up to 2 circuits**

**Example: Flow Maintenance – Greasy Waste Line**

Total heating cable length      223 ft of 12XL2-CT (from Step 3)  
 Supply voltage                      208 V (from Step 1)  
 Minimum start-up temperature    50°F (10°C) (from Step 1)  
 Number of circuits                  223 ft / 428 ft = 0.8 circuits  
**Round up to 1 circuit**

**DETERMINE TRANSFORMER LOAD**

Transformers must be sized to handle the load of the heating cable. Use the following tables to calculate the total transformer load.

**Table 11 Transformer Sizing (Amperes/foot)**

Minimum start-up temperature (°F)	5XL1	8XL1	5XL2			8XL2			12XL2		
	120	120	208	240	277	208	240	277	208	240	277
-20	0.119	0.159	0.069	0.067	0.065	0.092	0.087	0.082	0.108	0.106	0.102
0	0.105	0.139	0.060	0.059	0.057	0.080	0.076	0.072	0.100	0.098	0.095
20	0.090	0.120	0.052	0.051	0.049	0.069	0.066	0.062	0.095	0.093	0.090
40	0.075	0.101	0.043	0.042	0.041	0.058	0.055	0.052	0.084	0.083	0.080
50	-	-	-	-	-	0.053	0.050	0.047	0.079	0.077	0.075
65	-	-	-	-	-	0.044	0.042	0.040	0.072	0.070	0.067

**Table 12 Transformer Sizing (Amperes/meter)**

Minimum start-up temperature (°C)	5XL1	8XL1	5XL2			8XL2			12XL2		
	120	120	208	240	277	208	240	277	208	240	277
-20	0.391	0.521	0.226	0.221	0.215	0.301	0.286	0.270	0.354	0.347	0.336
-18	0.343	0.457	0.198	0.194	0.188	0.264	0.251	0.238	0.329	0.322	0.312
-7	0.294	0.394	0.170	0.166	0.161	0.227	0.216	0.205	0.311	0.305	0.296
4	0.246	0.331	0.142	0.139	0.135	0.191	0.181	0.172	0.276	0.271	0.263
10	-	-	-	-	-	0.172	0.164	0.155	0.259	0.254	0.246
18	-	-	-	-	-	0.145	0.138	0.130	0.233	0.228	0.221

Use Table 11 or Table 12 to determine the applied voltage and the maximum A/ft (A/m) at the minimum start up temperature to calculate the transformer load as follows:

$$\frac{\text{Max A/ft at minimum start-up temperature} \times \text{Heating cable length (ft)}}{1000} = \text{Transformer load (kW)}$$

**Example: Pipe Freeze Protection – Water Piping**

Total heating cable length            315 ft of 5XL1-CR (from Step 3)  
 Minimum start-up temperature        -20°F (-29°C) (from Step 1)  
 Circuit breaker sizing                    30 A

$$\frac{\text{Max A/ft at } -20^{\circ}\text{F} \times \text{Total feet}}{1000} = (0.119 \text{ A/ft} \times 315 \text{ ft} \times 120 \text{ V}) / 1000$$

$$\text{Transformer load (kW)} = 4.5 \text{ kW}$$

**Example: Flow Maintenance – Greasy Waste Line**

Total heating cable length	212 ft of 12XL2-CT (from Step 3)
Supply voltage	208 V
Minimum start-up temperature	50°F (10°C) (from Step 1)
Maximum circuit length	$T_M = 110^\circ\text{F}, 304 \text{ ft}$

$$\frac{\text{Max A/ft at } 50^\circ\text{F} \times \text{Total feet} \times \text{Supply voltage}}{1000} = (0.079 \text{ A/ft} \times 212 \text{ ft} \times 208 \text{ V}) / 1000$$

**Transformer load (kW) = 3.5 kW**

Pipe Freeze Protection and Flow Maintenance
1. Determine design conditions and heat loss
2. Select the heating cable
3. Determine the heating cable length
4. Determine the electrical parameters
5. Select the connection kits and accessories
6. Select the control system
7. Select the power distribution
8. Complete the Bill of Materials

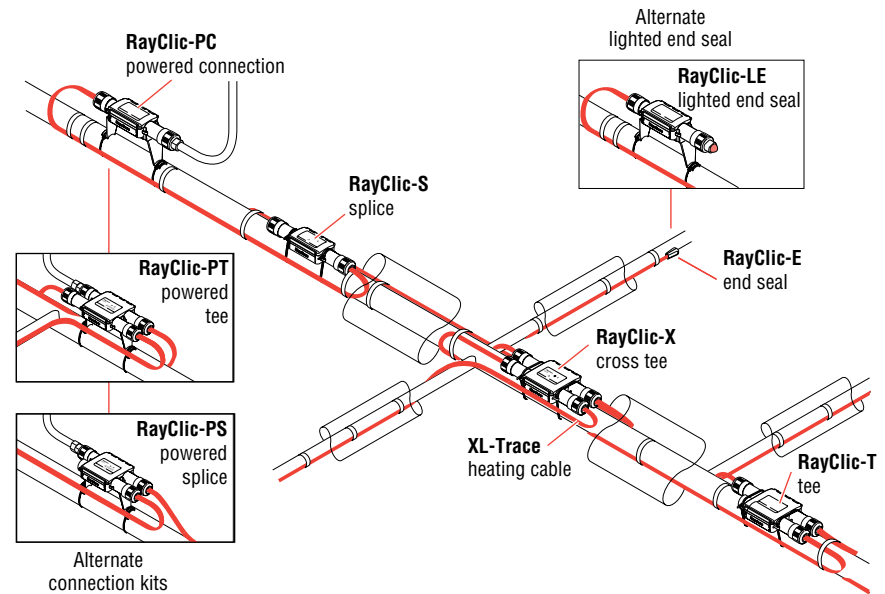
**Step 5 Select the connection kits and accessories**

All XL-Trace systems require a power connection and end seal kit. Splice and tee kits are used as required. Use Table 13 on page 27 (for aboveground applications) and Table 15 on page 29 (for buried applications) to select the appropriate connection kits.

**Note** Add extra cable on your Bill of Materials for power connections, tees, and end seals. See Table 13 on page 27, Table 15 on page 29, and Table 16 on page 30 for more information.

**WARNING:** Approvals and performance are based on the use of Tyco Thermal Controls-specified parts only. Do not substitute parts or use vinyl electrical tape.

**ABOVEGROUND PIPING**

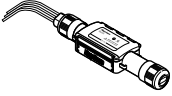
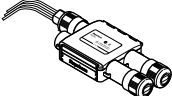
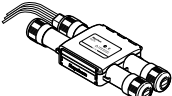
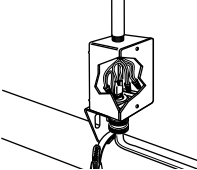
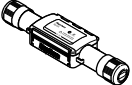
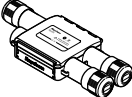
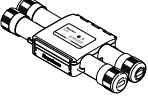
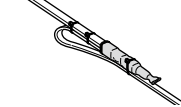
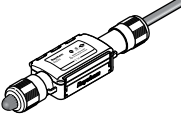



**Fig. 14 RayClic connection system**

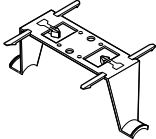
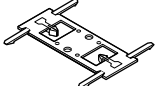

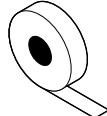

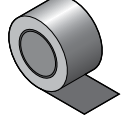
Use the following table for general piping, standpipe sprinkler piping, and greasy waste and fuel lines. Develop a bill of materials from the connection kits listed in this table.

**Note** Connection kits must be off the pipe when installed on greasy waste, fuel oil, or pipes exceeding 150°F (65°C).

**Table 13 Connection Kits and Accessories for Aboveground Piping**

	Catalog number	Description	Standard packaging	Usage	Heating cable allowance <sup>1</sup>
<b>Connection kits</b>					
	RayClic-PC	Power connection and end seal (RayClic-SB-04 pipe mounting bracket included)	1	1 per circuit	2 ft (0.6 m)
	RayClic-PS	Powered splice and end seal (RayClic-SB-04 pipe mounting bracket included)	1	1 per circuit	4 ft (1.2 m)
	RayClic-PT	Powered tee and end seal (RayClic-SB-04 pipe mounting bracket included)	1	1 per circuit	6 ft (1.8 m)
	FTC-P <sup>2</sup>	Power connection and end seal  <b>Note:</b> FTC-P is required for circuits requiring 40 A circuit breakers.	1	1 per circuit	3 ft (0.9 m)
	RayClic-S	Splice	1	As required	2 ft (0.6 m)
	RayClic-T	Tee kit with end seal	1	As required	3 ft (0.9 m)
	RayClic-X	Cross connection to connect four heating cables	1	As required	8 ft (2.4 m)
	FTC-HST <sup>3</sup>	Low-profile splice/tee	2	As required	3 ft (0.9 m)
	RayClic-LE	Lighted end seal (RayClic-SB-04 pipe mounting bracket included)	1	Alternate end seal	2 ft (0.6 m)
	RayClic-E	Extra end seal	1	Additional end seal	0.3 ft (0.1 m)

**Table 13 Connection Kits and Accessories for Aboveground Piping (Continued)**

	Catalog number	Description	Standard packaging	Usage	Heating cable allowance <sup>1</sup>
<b>Accessories</b>					
	RayClic-SB-04	Pipe mounting bracket	1	As required	-
	RayClic-SB-02	Wall mounting bracket	1	As required	-
	ETL	"Electric-Traced" label	1	1 label per 10 feet (3 m) of pipe	-
	GT-66	Glass cloth adhesive tape	66 ft (20 m)	See Table 14	-
	GS-54	Glass cloth adhesive tape	54 ft (20 m)	See Table 14	-
	AT-180	Aluminum tape - required for installing heating cable on plastic pipe	180 ft (55 m)	1 ft/ft [0.3 m/m] of heating cable	-

<sup>1</sup> Allow extra heating cable for ease of component installation.

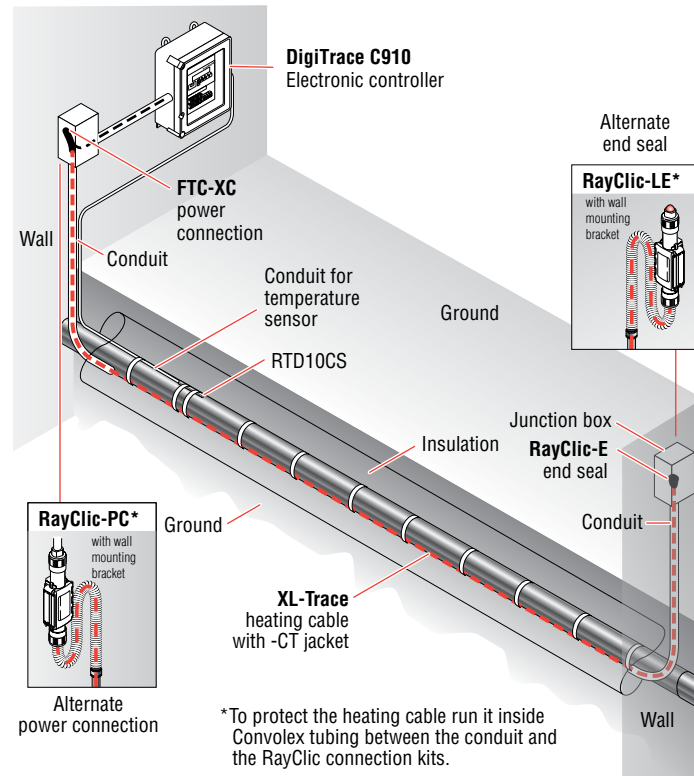
<sup>2</sup> Junction box not included.

<sup>3</sup> One RayClic-E end seal is required for each FTC-HST used as a tee kit.

**Table 14 Quantity of Glass Cloth Adhesive Tape Required (attach at 1-foot intervals)**

Pipe size (in)	<2	3	4	6	8	10
Feet of pipe per GT-66 roll	60 (18 m)	50 (15 m)	40 (12 m)	25 (8 m)	20 (6 m)	15 (5 m)
Feet of pipe per GS-54 roll	49 (15 m)	41 (13 m)	33 (10 m)	20 (6 m)	16 (5 m)	12 (4 m)

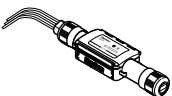
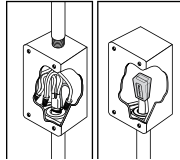
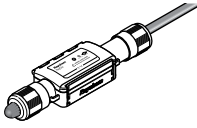

**BURIED PIPING**



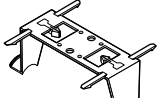
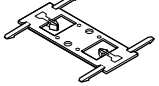



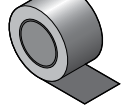
**Fig. 15 Typical buried piping system**

Use the following for buried water piping and greasy waste lines. Note that all connections must be aboveground and that no splices/tees are allowed. Develop a bill of materials from the connection kits in this table.

**Table 15 Connection Kits and Accessories for Buried Piping**

	Catalog number	Description	Standard packaging	Usage	Heating cable allowance <sup>1</sup>
	RayClic-PC	Power connection and end seal (RayClic-SB-04 pipe mounting bracket included)	1	1 per circuit	2 ft (0.6 m)
	FTC-XC	The FTC-XC power connection and end seal kit is for use with XL-Trace heating cable that is run through conduit to a junction box. Materials for one power connection and end seal is included in the kit.  <b>Note:</b> FTC-XC is required for circuits requiring 40 A circuit breakers.	1	1 per circuit	2 ft (0.6 m)
	RayClic-LE	Lighted end seal (RayClic-SB-04 pipe mounting bracket included)	1	Alternate end seal	2 ft (0.6 m)
	RayClic-E	Extra end seal	1	Additional end seal	0.3 ft (0.1 m)

**Table 15 Connection Kits and Accessories for Buried Piping (Continued)**

	Catalog number	Description	Standard packaging	Usage	Heating cable allowance <sup>1</sup>
<b>Accessories</b>					
	RayClic-SB-04	Pipe mounting bracket	1	As required	–
	RayClic-SB-02	Wall mounting bracket	1	As required	–
	ETL	“Electric-Traced” label	1	1 label per 10 feet (3 m) of pipe	–
	GT-66	Glass cloth adhesive tape	66 ft (20 m)	See Table 16	–
	GS-54	Glass cloth adhesive tape	54 ft (20 m)	See Table 16	–
	AT-180	Aluminum tape - required for installing heating cable on plastic pipe	180 ft (55 m)	1 ft/ft [0.3 m/m] of heating cable	–

<sup>1</sup> Allow extra heating cable for ease of component installation.

**Table 16 Quantity of Glass Cloth Adhesive Tape Required (attach at 1-foot intervals)**

Pipe size (in)	<2	3	4	6	8	10
Feet of pipe per GT-66 roll	60 (18 m)	50 (15 m)	40 (12 m)	25 (8 m)	20 (6 m)	15 (5 m)
Feet of pipe per GS-54 roll	49 (15 m)	41 (13 m)	33 (10 m)	20 (6 m)	16 (5 m)	12 (4 m)





Pipe Freeze Protection and Flow Maintenance
1. Determine design conditions and heat loss
2. Select the heating cable
3. Determine the heating cable length
4. Determine the electrical parameters
5. Select the connection kits and accessories
6. Select the control system
7. Select the power distribution
8. Complete the Bill of Materials

## Step 6 Select the control system

Temperature controls save energy by ensuring that the system is energized only when necessary. Tyco Thermal Controls offers a wide variety of monitoring and control options, including:

- Mechanical thermostats provide a cost effective control solution.
- Electronic thermostats provide higher accuracy of the heating cable circuit with thermistor sensors.
- Electronic controllers provide superior accuracy with RTD temperature sensors, built-in ground-fault protection, monitoring and alarm output.
- Modbus® protocol communication over RS-485 system is supported using DigiTrace ProtoNode multi-protocol gateways.

 **Note:** Fire sprinkler standpipe freeze protection requires DigiTrace C910, DigiTrace C910-485 or ACCS-30 controllers with alarm relays connected to the fire control panel.

 **Note:** Greasy waste flow maintenance requires line sensing controllers such as the DigiTrace EC-TS or DigiTrace C910, or the DigiTrace ACCS-30.

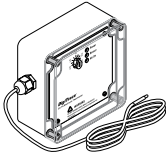
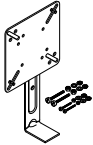


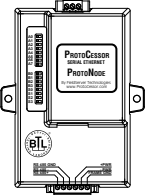
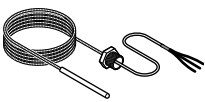
Use the following table to identify the control system suitable for your application. Contact your Tyco Thermal Controls representative or contact Tyco Thermal Controls directly at (800) 545-6258 for more information.

**Table 17 Temperature Control Options**

Application	Electronic thermostat	Electronic controllers	
		Single-point	Multipoint
	EC-TS	DigiTrace C910*	ACCS-30
Ambient sensing	X	X	X
Line sensing	X	X	X
Buried pipe	X	X	X
Fire sprinklers	–	X	X
Sensor	Thermistor	See data sheet	See data sheet
Sensor length	–	10 ft	"
Set point range	30°F to 110°F (–1°C to 43°C)	–76°F to 1058°F (–60°C to 570°C)	"
Enclosure	NEMA 4X	NEMA 4X	"
Differential	3°F (1.6°C)	3°F (1.6°C)	"
Set point repeatability	3°F (1.6°C)	3°F (1.6°C)	"
Enclosure limits	–40°F to 140°F (–40°C to 60°C)	–40°F to 140°F (–40°C to 60°C)	"
Switch rating	30 A	30 A	"
Switch type	SPST	DPST	"
Electrical rating	100–277 V	100–277 V	"
Approvals	c-UL-us	c-CSA-us	"
Ground-fault protection	–	20 mA to 250 mA	"
Alarm outputs			"
AC relay	–	100–277 V, 0.75 A max.	"
Dry contact relay	–	48 Vac/dc, 500 mA max.	"

\* The C910-485 is available to provide RS-485 communication capability. Connect to the BMS using DigiTrace ProtoNode multi-protocol gateways

**Table 18 Control Systems**

	Catalog number	Description
<b>Electronic Thermostats and Accessories</b>		
	EC-TS	Electronic thermostat housed in a NEMA 4X enclosure with 2 x 1/2-in conduit entries for power and one gland entry for the sensor. The temperature set point and LED indicators for alarm, power, and heating cable status can be visually checked through the clear lid. Electrical rating is 30 A at 100–277 V, 50–60 Hz, SPST switch. EC-TS includes a 25 ft (7.6 m) sensor.
	SB-110	Pipe mounting bracket for EC-TS
<b>Electronic Controllers and Sensors</b>		
	C910 C910-485	The C910 is a compact, full-featured microprocessor-based single-point heat-trace controller. The C910 provides control and monitoring of electrical heat-tracing circuits for both freeze protection and temperature maintenance, and can be set to monitor and alarm for high and low temperature, high and low current, ground-fault level, and voltage. The DigiTrace C910 controller is available with an electromechanical relay (EMR) for use in ordinary areas. The C910-485 comes with an RS-485 communication module.
	ACCS-UIT2 ACCS-PCM2-5	The DigiTrace ACCS-30 Advanced Commercial Control System is a multipoint electronic control and monitoring system for heat-tracing used in commercial freeze protection and flow maintenance applications. The DigiTrace ACCS-30 system can control up to 260 circuits with multiple networked ACCS-PCM2-5 panels, with a single ACCS-UIT2 user interface terminal. The ACCS-PCM2-5 panel can directly control up to 5 individual heat-tracing circuits using electromechanical relays rated at 30 A up to 277 V.
	ProtoNode-LER ProtoNode-RER	The DigiTrace ProtoNode is an external, high performance multi-protocol gateway for customers needing protocol translation between Building Management Systems (BMS) and the DigiTrace ACCS-30 or C910-485 controllers.  The ProtoNode-LER is for LonWorks® systems; and the ProtoNode-RER is for BACnet® or Metasys® N2 systems.
	RTD-200 RTD3CS RTD10CS	Three-wire RTD (Resistance Temperature Device) used with DigiTrace C910 and ACCS-30 controllers.  RTD-200: 6-ft (1.8 m) fluoropolymer with 1/2-in NPT bushing RTD3CS: 3-ft (0.9 m) flexible armor with 1/2-in NPT bushing RTD10CS: 10-ft (3 m) flexible armor with 1/2-in NPT bushing

Pipe Freeze Protection and Flow Maintenance
1. Determine design conditions and heat loss
2. Select the heating cable
3. Determine the heating cable length
4. Determine the electrical parameters
5. Select the connection kits and accessories
6. Select the control system
7. Select the power distribution
8. Complete the Bill of Materials

**Step 7 Select the power distribution**

Once the heating cable circuits have been defined, you must select how to provide power to them. Power to the XL-Trace heating cables can be provided in several ways: directly through the temperature control, through external contactors, or through HTPG power distribution panels.

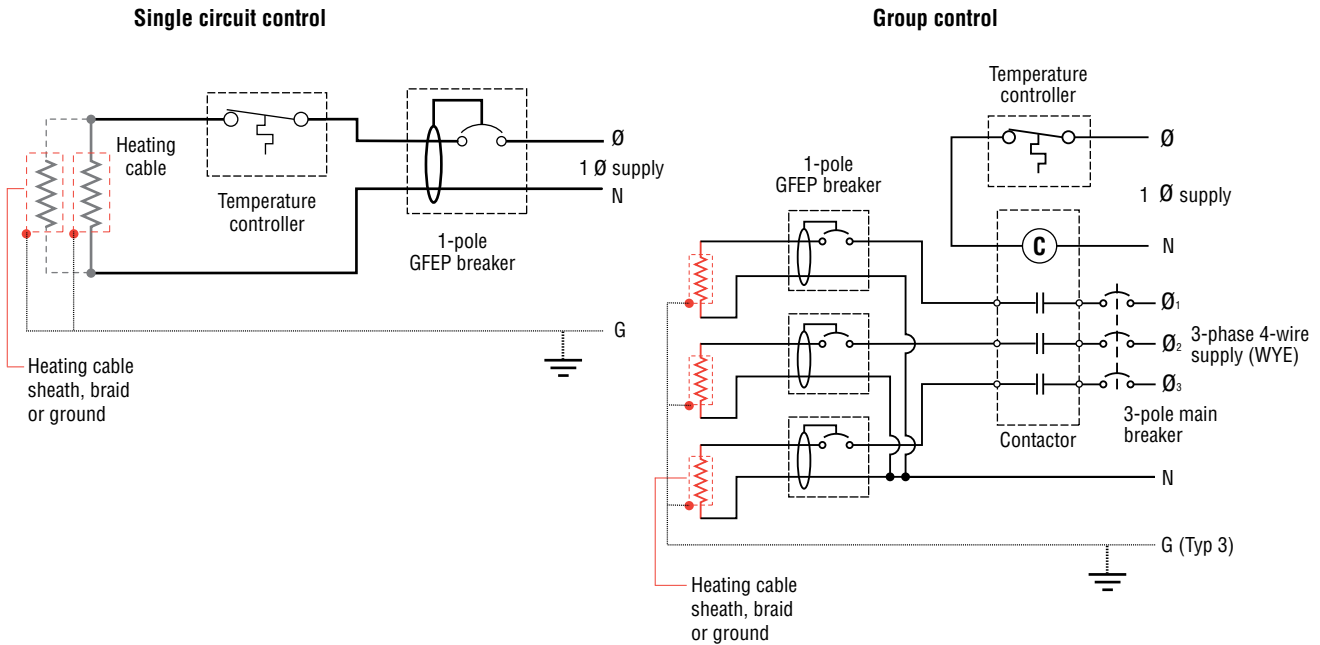
**SINGLE CIRCUIT CONTROL**

Heating cable circuits that do not exceed the current rating of the selected temperature control device shown in Table 18 can be switched directly (see Fig. 16).

**GROUP CONTROL**

If the current draw exceeds the switch rating, or if the controller will activate more than one circuit (group control, an external contactor must be used (see Fig. 16 on page 33).

Large systems with many circuits should use an HTPG power distribution panel. The HTPG is a dedicated power-distribution, control, ground-fault protection, monitoring, and alarm panel for freeze protection and broad temperature maintenance heat-tracing applications. This enclosure contains an assembled circuit-breaker panelboard. Panels are equipped with ground-fault circuit breakers with or without alarm contacts. The group control package allows the system to operate automatically in conjunction with an ambient-sensing thermostat, individual electronic, or duty cycle controller.



**Fig. 16 Single circuit and group control**

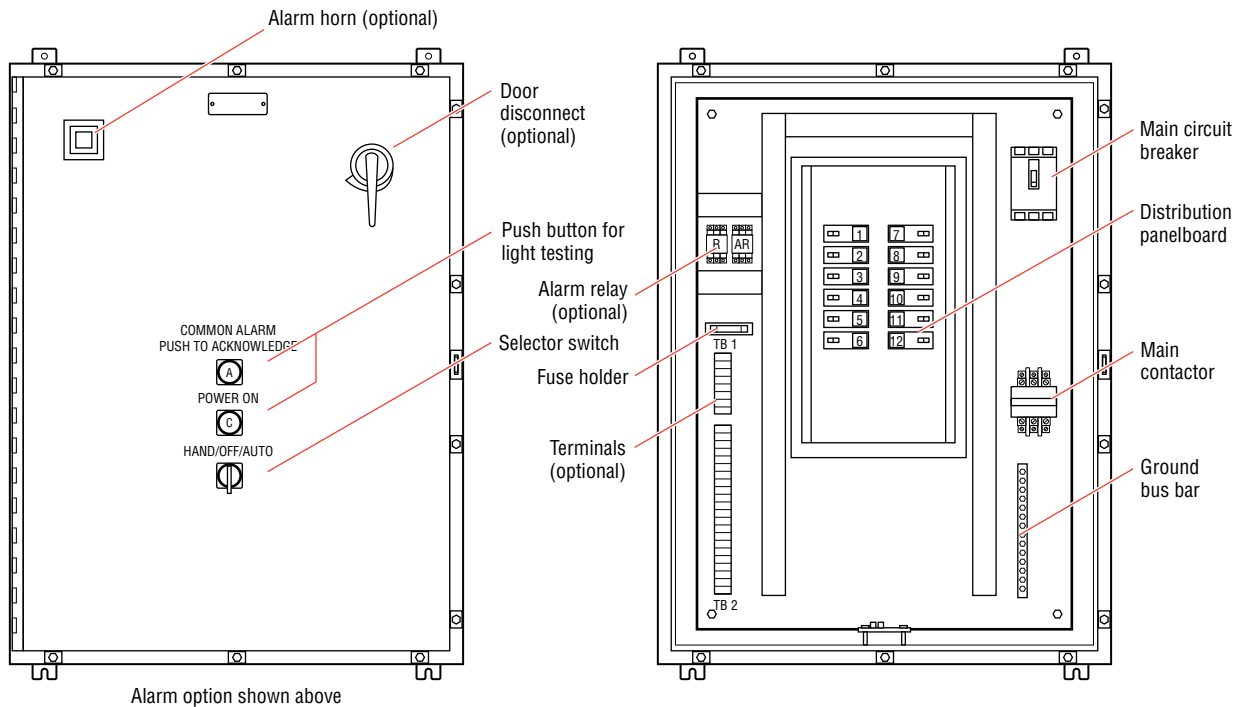


Fig. 17 HTPG power distribution panel

Three-phase, 4 wire supply (Wye)

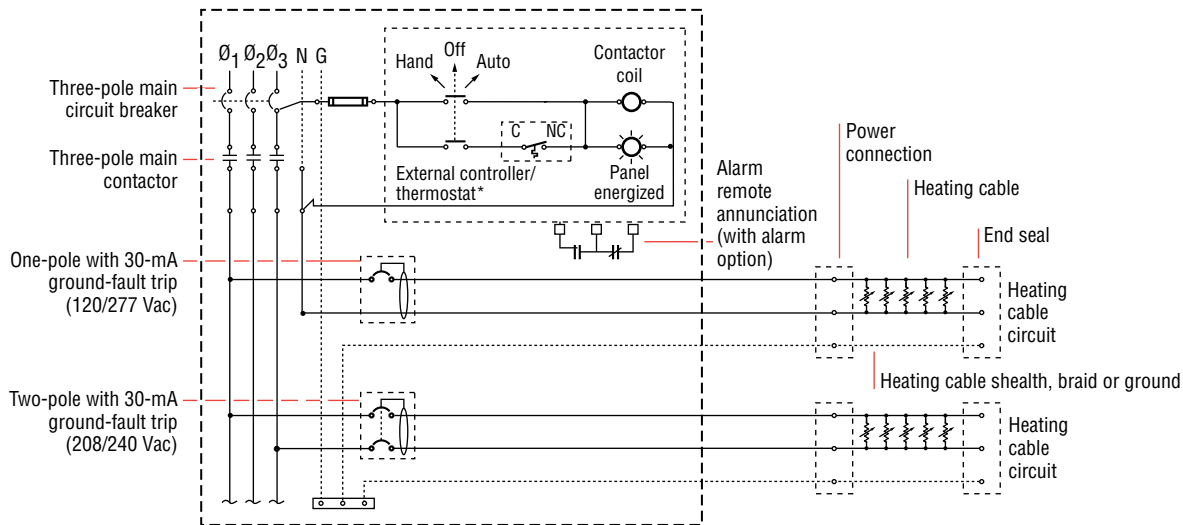

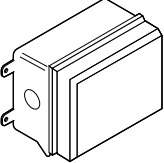
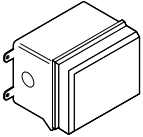


Fig. 18 HTPG power schematic

**Table 19 Power Distribution**

	Catalog number	Description
<b>Power Distribution</b>		
	HTPG	Heat-tracing power distribution panel with ground-fault and monitoring for group control.
<b>Contactors</b>		
	E104	Three-pole, 100 Amp per pole, 600 V maximum contactor housed in UL Listed, CSA Certified, NEMA 4X enclosure with two 1-inch conduit entries. When ordering, select coil voltage (110–120, 208–240, 277 V).  Enclosure dimensions: 13-1/2 in x 9-1/5 in x 6-11/16 in (343 mm x 234 mm x 170 mm).
	E304	Three-pole, 40 Amp per pole, 600 V maximum contactor housed in UL Listed, CSA Certified NEMA 4X enclosure with two 1-inch conduit entries. When ordering, select coil voltage (110–120, 208–240, 277 V).  Enclosure dimensions: 9-1/2 in x 7-1/5 in x 6-11/16 in (241 mm x 183 mm x 170 mm).

Pipe Freeze Protection and Flow Maintenance
1. Determine design conditions and heat loss
2. Select the heating cable
3. Determine the heating cable length
4. Determine the electrical parameters
5. Select the connection kits and accessories
6. Select the control system
7. Select the power distribution
8. Complete the Bill of Materials

**Step 8 Complete the Bill of Materials**

If you used the Design Worksheet to document all your design parameters, you should have all the details necessary complete your Bill of Materials.

## XL-Trace System Pipe Freeze Protection and Flow Maintenance Design Worksheet

### Step 1 Determine design conditions and pipe heat loss

#### Design conditions

XL-Trace application	Location		Maintain temp. (T <sub>M</sub> )	Max. system temp. (T <sub>MAX</sub> )	Min. ambient temp. (T <sub>A</sub> )	Pipe diameter and material	Pipe length	Thermal insulation type and thickness
<b>Pipe freeze protection</b>								
<input type="checkbox"/> Water piping	<input type="checkbox"/> Indoors <input type="checkbox"/> Outdoors	<input type="checkbox"/> Aboveground <input type="checkbox"/> Buried	_____	_____	_____	____ in <input type="checkbox"/> Metal <input type="checkbox"/> Plastic	_____ ft (m)	<input type="checkbox"/> Fiberglass <input type="checkbox"/> _____ in
<input type="checkbox"/> Sprinkler piping	<input type="checkbox"/> Indoors <input type="checkbox"/> Outdoors	<input type="checkbox"/> Aboveground <input type="checkbox"/> Buried	_____	_____	_____	____ in <input type="checkbox"/> Metal <input type="checkbox"/> Plastic	_____ ft (m)	<input type="checkbox"/> Fiberglass <input type="checkbox"/> _____ in
<b>Flow maintenance</b>								
<input type="checkbox"/> Greasy waste lines	<input type="checkbox"/> Indoors <input type="checkbox"/> Outdoors	<input type="checkbox"/> Aboveground <input type="checkbox"/> Buried	_____	_____	_____	____ in <input type="checkbox"/> Metal <input type="checkbox"/> Plastic	_____ ft (m)	<input type="checkbox"/> Fiberglass <input type="checkbox"/> _____ in
<input type="checkbox"/> Fuel lines	<input type="checkbox"/> Indoors <input type="checkbox"/> Outdoors	<input type="checkbox"/> Aboveground <input type="checkbox"/> Buried	_____	_____	_____	____ in <input type="checkbox"/> Metal <input type="checkbox"/> Plastic	_____ ft (m)	<input type="checkbox"/> Fiberglass <input type="checkbox"/> _____ in
<b>Example:</b> ✓ Water piping	✓ Aboveground ✓ Outdoor		40°F	80°F	-20°F	2 in ✓ Plastic	300 ft	✓ Fiberglass 1 in

#### Pipe heat loss

#### Calculate temperature differential ΔT

Pipe maintain temperature (T<sub>M</sub>) \_\_\_\_\_ °F (°C)

Ambient temperature (T<sub>A</sub>) \_\_\_\_\_ °F (°C)

$$\underline{\quad T_M \quad} - \underline{\quad T_A \quad} \longrightarrow = \underline{\quad \Delta T \quad}$$

#### Example: Pipe Freeze Protection – Water Piping

Pipe maintain temperature (T<sub>M</sub>) 40 °F (from Step 1)  
°F

Ambient temperature (T<sub>A</sub>) -20 °F (from Step 1)  
°F

$$\underline{\quad 40 \text{ °F} \quad} - \underline{\quad -20 \text{ °F} \quad} \longrightarrow = \underline{\quad 60 \text{ °F} \quad}$$

$T_M \quad \quad T_A \quad \quad \quad \Delta T$

**Determine the pipe heat loss:** See Table 2 for the base heat loss of the pipe ( $Q_B$ ). If the  $\Delta T$  for your system is not listed, interpolate between the two closest values.

$Q_{B-50} \Delta T1$	_____
	W/ft (W/m)
$Q_{B-100} \Delta T2$	_____
	W/ft (W/m)
$Q_B$	_____
	W/ft (W/m)
Pipe diameter	_____
	in
Insulation thickness	_____
	in
$\Delta T$	_____
	°F (°C)
$Q_{B-50}$	_____
	W/ft (W/m)
$Q_{B-100}$	_____
	W/ft (W/m)

**Example: Pipe Freeze Protection – Water Piping**

Pipe diameter	_____	2 in
Insulation thickness	_____	1 in
$\Delta T$	_____	60°F
$Q_{B-50}$	_____	3.2 W/ft
$Q_{B-100}$	_____	6.8 W/ft
$\Delta T$ interpolation	$\Delta T$ 60°F is 20% of the distance between $\Delta T$ 50°F and $\Delta T$ 100°F	
	$Q_{B-50} + [0.20 \times (Q_{B-100} - Q_{B-50})]$	
$Q_{B-60}$	$3.2 + [0.20 \times (6.8 - 3.2)] = 3.9$ W/ft	
Pipe heat loss ( $Q_{B-60}$ )	<b>3.9 W/ft @ <math>T_M</math> 40°F</b>	



**Compensate for insulation type and pipe location**

See Table 2 for the pipe heat loss ( $Q_B$ ). If the  $\Delta T$  for your system is not listed, interpolate between the two closest values.

See Table 3 for indoor multiple

See Table 4 for insulation multiple

Location \_\_\_\_\_

Insulation thickness and type \_\_\_\_\_

$Q_B$  \_\_\_\_\_  
W/ft (W/m)

Insulation multiple \_\_\_\_\_

Indoor multiple (if applicable) \_\_\_\_\_

$$\frac{Q_B}{Q_B} \times \frac{\text{Insulation multiple}}{\text{Insulation multiple}} \times \frac{\text{Indoor multiple (if applicable)}}{\text{Indoor multiple (if applicable)}} = Q_{\text{CORRECTED}}$$

**Example: Pipe Freeze Protection – Water Piping**

Location Aboveground, indoor

Thermal insulation thickness and type 1-in fiberglass

$Q_B$  3.9 W/ft @  $T_M$  40°F

Insulation multiple 1.00

Indoor multiple N/A

$$Q_{\text{CORRECTED}} = \frac{3.9 \text{ W/ft}}{Q_B} \times \frac{1.00}{\text{Insulation multiple}} = 3.9 \text{ W/ft @ } T_M \text{ 40°F}$$

**Step 2 Select the heating cable**

**Power output data:** See Fig. 13

**Power output correction factors:** See Table 5

**Heating cable temperature ratings:** See Table 6

Pipe maintain temperature ( $T_M$ ) \_\_\_\_\_ (from Step 1)

Corrected heat loss ( $Q_{CORRECTED}$ ) \_\_\_\_\_ (from Step 1)

Supply voltage \_\_\_\_\_ (from Step 1)

Pipe material (metal or plastic) \_\_\_\_\_ (from Step 1)

XL-Trace application (water, fuel oil, or greasy waste) \_\_\_\_\_ (from Step 1)

    Pipe freeze protection: general water piping, sprinkler piping \_\_\_\_\_

    Flow maintenance: greasy waste lines, fuel lines \_\_\_\_\_

Maximum system use temperature ( $T_{MAX}$ ) \_\_\_\_\_ (from Step 1)

Heating cable selected \_\_\_\_\_ (from Step 1)

Power at  $T_M$  (120/208 V) \_\_\_\_\_

Power output correction factor \_\_\_\_\_ (from Step 1)

Plastic pipe correction factor \_\_\_\_\_

\_\_\_\_\_ x \_\_\_\_\_ = \_\_\_\_\_

Power at rated V factor      Plastic pipe correction factor      Corrected power

Is the heating cable power output ( $P_{CORRECTED}$ )  $\geq$  the corrected heat loss?  Yes  No

If No, then design with additional runs of heating cable or thicker thermal insulation.

**Example: Pipe Freeze Protection – Water Piping**

Maintain temperature ( $T_M$ ) \_\_\_\_\_ 40°F

Corrected heat loss ( $Q_{CORRECTED}$ ) \_\_\_\_\_ 3.9 W/ft @  $T_M$  40°F

Supply voltage \_\_\_\_\_ 120 V

Pipe material (metal or plastic\*) \_\_\_\_\_ plastic

(\*AT-180 aluminum tape required for installing heating cable on plastic pipes)

$Q_B = 3.9 \text{ W/ft @ } T_M \text{ 40°F}$   
 Select curve C: 5XL1 = **5.6 W/ft @ 40°F**  
 Power output correction factor: 120 V = 1.00  
 Pipe material correction factor: Plastic = 0.75  
 Corrected heating cable power: 5.6 @/ft x 1.00 x 0.75 = **4.2 W/ft**  
 Select: **5XL1**  
 Maximum system temperature ( $T_{MAX}$ ): 80°F  
 Maximum heating cable exposure temperature ( $T_{EXP}$ ): 150°F  
 $T_{MAX} < T_{EXP}$ : Yes

**Select outer jacket**

- CR
- CT

**Example: Pipe Freeze Protection – Water Piping**  
**5XL1-CR**

**Step 3 Determine the heating cable length**

For additional heating cable allowance for valves: See Table 7.

For additional heating cable allowance for pipe supports and flanges: See Table 8.

**Heat sinks**

$$\frac{\text{Type of valves}}{\text{How many}} \times \frac{\text{Additional heating cable}}{\text{Additional heating cable}} = \frac{\text{Total heating cable for valves}}{\text{Total heating cable for valves}}$$

$$\frac{\text{Type of pipe supports}}{\text{How many}} \times \frac{\text{Additional heating cable}}{\text{Additional heating cable *2-in pipe diameter = 0.17 ft}} = \frac{\text{Total heating cable for pipe supports}}{\text{Total heating cable for pipe supports}}$$

$$\frac{\text{Type of flanges}}{\text{How many}} \times \frac{\text{Additional heating cable}}{\text{Additional heating cable}} = \frac{\text{Total heating cable for flanges}}{\text{Total heating cable for flanges}}$$

**Total heating cable for heat sinks:** \_\_\_\_\_

**Total heating cable length**

$$\left( \frac{\text{Pipe length}}{\text{Pipe length}} \times \frac{\text{Number of heating cable runs}}{\text{Number of heating cable runs}} \right) + \frac{\text{Additional cable for valves, pipe supports, and flanges}}{\text{Additional cable for valves, pipe supports, and flanges}} = \frac{\text{Total heating cable length required}}{\text{Total heating cable length required}}$$

**Example:**

**Heat sinks**

$$\frac{\text{Gate valves}}{\text{How many}} \times \frac{\text{Additional heating cable}}{\text{Additional heating cable}} = \frac{\text{Total}}{\text{Total}}$$

$$\frac{\text{Pipe hangers noninsulated and U-bolt supports}}{\text{How many}} \times \frac{\text{Additional heating cable}}{\text{Additional heating cable *2-in pipe diameter = 0.17 ft}} = \frac{\text{Total}}{\text{Total}}$$

$$\frac{\text{n/a}}{\text{How many}} \times \frac{\text{Additional heating cable}}{\text{Additional heating cable}} = \frac{\text{Total}}{\text{Total}}$$

**Total: 14.6 ft rounded up to 15 ft**

**Total heating cable length**

$$\left( \frac{300 \text{ ft}}{\text{Pipe length}} \times \frac{1}{\text{Number of heating cable runs}} \right) + \frac{15 \text{ ft}}{\text{Additional cable for valves, pipe supports, and flanges}} = \frac{315 \text{ ft}}{\text{Total heating cable length required}}$$

**Step 4 Determine the electrical parameters**

**Determine maximum circuit length and number of circuits**

See Table 9 and Table 10.

Total heating cable length required \_\_\_\_\_

Supply voltage:     120 V     208 V  
                            240 V     277 V

Circuit breaker size:     15 A     20 A  
                                    30 A     40 A

Minimum start-up temperature \_\_\_\_\_

Maximum circuit length \_\_\_\_\_

$$\frac{\text{Total heating cable length required}}{\text{Maximum heating cable circuit length}} = \text{Number of circuits}$$

**Example:**

Total heating cable length required 315 ft of 5XL1-CR

Supply voltage:     120 V     208 V  
                            240 V     277 V

Circuit breaker size:     15 A     20 A  
                                    30 A     40 A

Minimum start-up temperature -20°F

Maximum circuit length 201 ft

$$\frac{315 \text{ ft}}{201 \text{ ft}} = 1.6 \text{ circuits, round up to 2}$$

Number of circuits

**Determine transformer load**

See Table 11 and Table 12.

$$\frac{\text{Max A/ft at minimum start-up temperature}}{\text{Heating cable length}} \times \frac{\text{Supply voltage}}{1000} = \text{Transformer load (kW)}$$

**Example:**

$$\frac{0.119 \text{ A/ft}}{315 \text{ ft}} \times \frac{120 \text{ V}}{1000} = 4.5 \text{ kW}$$

Transformer load (kW)

**Step 5 Select the connection kits and accessories**

See Table 13.

Connection kits – Aboveground	Description	Quantity	Heating cable allowance
<input type="checkbox"/> RayClic-PC	Power connection and end seal	_____	_____
<input type="checkbox"/> RayClic-PS	Power splice and end seal	_____	_____
<input type="checkbox"/> RayClic-PT	Powered tee and end seal	_____	_____
<input type="checkbox"/> FTC-P	Power connection and end seal	_____	_____
<input type="checkbox"/> RayClic-S	Splice	_____	_____
<input type="checkbox"/> RayClic-T	Tee kit with end seal	_____	_____
<input type="checkbox"/> RayClic-X	Cross connection	_____	_____
<input type="checkbox"/> FTC-HST	Low-profile splice/tee	_____	_____
<input type="checkbox"/> RayClic-LE	Lighted end seal	_____	_____
<input type="checkbox"/> RayClic-E	Extra end seal	_____	_____
Connection kits – Buried	Description	Quantity	Heating cable allowance
<input type="checkbox"/> RayClic-PC	Power connection and end seal	_____	_____
<input type="checkbox"/> FTC-XC	Power splice and end seal	_____	_____
<input type="checkbox"/> RayClic-LE	Lighted end seal	_____	_____
<input type="checkbox"/> RayClic-E	Extra end seal	_____	_____
Accessories – Aboveground and buried	Description	Quantity	
<input type="checkbox"/> RayClic-SB-04	Pipe mounting bracket	_____	
<input type="checkbox"/> RayClic-SB-02	Wall mounting bracket	_____	
<input type="checkbox"/> ETL	“Electric-Traced” label	_____	
<input type="checkbox"/> GT-66	Glass cloth adhesive tape	_____	
<input type="checkbox"/> GS-54	Glass cloth adhesive tape	_____	
<input type="checkbox"/> AT-180	Aluminum tape (for plastic pipes)	_____	

**Total heating cable allowance for connection kits**

$$\text{_____} + \text{_____} = \text{_____}$$

Total heating cable length      Total heating cable allowance for connection kits      **Total heating cable length required**

**Step 6 Select the control system**

See Table 18.

Thermostats, controllers and accessories	Description	Quantity
<input type="checkbox"/> EC-TS	Electronic thermostat with 25-ft sensor	_____
<input type="checkbox"/> SB-110	Pipe mounting bracket for EC-TS	_____
<input type="checkbox"/> DigiTrace C910	Microprocessor-based single-point heat-tracing controller	_____
<input type="checkbox"/> ACCS-UIT2	ACCS-30 user interface terminal	_____
<input type="checkbox"/> ACCS-PCM2-5	ACCS-30 power control panel	_____
<input type="checkbox"/> ProtoNode-LER	Multi-protocol gateway	_____
<input type="checkbox"/> ProtoNode-RER	Multi-protocol gateway	_____
<input type="checkbox"/> RTD3CS	Resistance temperature device	_____
<input type="checkbox"/> RTD10CS	Resistance temperature device	_____
<input type="checkbox"/> RTD-200	Resistance temperature device	_____

**Step 7 Select the power distribution**

See Table 19.

Power distribution	Description	Quantity
<input type="checkbox"/> HTPG	Heat-tracing power distribution panel for group control	_____

Contactors	Description	Quantity
<input type="checkbox"/> E104	Three-pole, 100 Amp per pole contactor	_____
<input type="checkbox"/> E304	Three-pole, 40 Amp per pole contactor	_____

**Step 8 Complete the Bill of Materials**

Use the information recorded in this worksheet to complete the Bill of Materials.

**Worldwide Headquarters  
Tyco Thermal Controls**

7433 Harwin Drive  
Houston, TX 77036  
USA  
Tel: 800-545-6258  
Tel: 650-216-1526  
Fax: 800-527-5703  
Fax: 650-474-7711  
info@tycothermal.com  
[www.tycothermal.com](http://www.tycothermal.com)

**Canada  
Tyco Thermal Controls**

250 West St.  
Trenton, Ontario K8V 5S2  
Canada  
Tel: 800-545-6258  
Fax: 800-527-5703  
Tel: 613-392-6571  
Fax: 613-392-3999

**Europe, Middle East, Africa  
Tyco Thermal Controls**

Romeinse straat 14  
3001 Leuven  
België / Belgique  
Tel: +32 16 213 511  
Fax: +32 16 213 603

**Latin America  
Tyco Thermal Controls**

Al. Araguaia, 2044 – Sala.1101,  
Bloco B  
Edifício CEA – Alphaville  
Barueri – Sao Paulo – Brasil  
06455-000  
Tel: +55 11 2588 1400  
Fax: +55 11 2588 1410

**Asia Pacific  
Tyco Thermal Controls**

20F, Innovation Building,  
1009 Yi Shan Rd,  
Shanghai 200233, P.R.China  
Tel: +86 21 2412 1688  
Fax: +86 21 5426 2937 / 5426 3167

Tyco, Alliance Integrated Systems, AMC, AutoMatrix, AutoSol, BTV, CapaciSense, Chemelex, DHSX, DigiTrace, DigiTrace logo, DigiTrace Supervisor, Duoterm, ElectroMelt, EM2XR, FHSM, FHSC, FlexFit, FlexiClic, Flowguard, FreezeTrace, FreezGard, Frostex, Frostex Plus, Frostguard, FroStop, FSE, Gardian, HAK, Handvise, HBTv, HCCL, HotCap, HQTV, HTPG, HTPi, HWAT, HXTV, IceStop, Interlock, JBM, JBS, K-Flex, K-Flex logo, KHE, KHH, KHL, KHP, KTV, Labsafe, LBTv, LHC, LHFV, LHRV, Metabond, Mini WinterGard, Miser WinterGard, MoniTrace, Multi-plus, NGC, PetroTrace, PLI, PolyMatrix, Pyro CiC, PyroFLX, Pyromaster, Pyropak, Pyrosil, PyroSizer, Pyrotenax, Pyrotenax Designer, Pyrotenax logo, QTVR, QuickNet, QuickNet logo, QuickStat, QuickTerm, RayClic, RaySol, RayStat, Retro WinterGard, RHS, RHSC, RHSM, RMM2, SBF, SBV, SC, SHC, Sheathmaster, ShowerGuard, SLBTv, Smart Heat for Comfort and Safety, SnoCalc, SnoCalc logo, STS, System 500, System 1850, System 1850-SE, System 2000, System 2200, T2, T2 logo, T2Blue, T2QuickNet, T2Red, T2Reflecta, TankCalc Plus, TempBus, Thermoheat, ThermoLimit, Thermo-Line, Total Care in Heat-tracing, Touch, Trac-Loc, Trac Calc, TraceCalc Net, TraceCalc Net logo, TraceCalc Pro logo, TraceGuard 277, TraceMaster, Tracer, Tracer logo, TRACERLYNX, TRACERLYNX logo, TraceStat, TraceTek, TraceTek logo, TruckPak, VLBTv, VLKTV, VPL, We manage the heat you need, WinterGard, WinterGard logo, WinterGard Plus, WinterGard Wet, XL-ERATE, XL-ERATE logo, XL-Trace, XTV and Zero EMI are registered and/or unregistered trademarks of Tyco Thermal Controls LLC or its affiliates.

All other trademarks are the property of their respective owners.

**tyco**  
**Thermal Controls**

**Important:** All information, including illustrations, is believed to be reliable. Users, however, should independently evaluate the suitability of each product for their particular application. Tyco Thermal Controls makes no warranties as to the accuracy or completeness of the information, and disclaims any liability regarding its use. Tyco Thermal Controls' only obligations are those in the Tyco Thermal Controls Standard Terms and Conditions of Sale for this product, and in no case will Tyco Thermal Controls or its distributors be liable for any incidental, indirect, or consequential damages arising from the sale, resale, use, or misuse of the product. Specifications are subject to change without notice. In addition, Tyco Thermal Controls reserves the right to make changes—without notification to Buyer—to processing or materials that do not affect compliance with any applicable specification.

# FOREMAN | MANHATTAN Construction Team

RFI #009

Foreman | Manhattan Construction Team  
5601 South 122nd East Avenue  
Tulsa, Oklahoma 74146  
Phone: (918) 583-6900  
Fax: (918) 592-4334

Project: 3882 - Tahlequah Cherokee Casino  
3307 S. Seven Clans Ave.  
Tahlequah, Oklahoma 74464

## Addendum 2 and Bid Package 2 Plumbing Schedule

<b>TO:</b>	Gary Moore (Childers)	<b>FROM:</b>	Luke Wilson (Manhattan - Tulsa) 5601 South 122nd East Avenue Tulsa, Oklahoma 74146
<b>DATE INITIATED:</b>	04/18/ 2018	<b>STATUS:</b>	Closed
<b>LOCATION:</b>		<b>DUE DATE:</b>	04/19/2018
<b>COST CODE:</b>		<b>REFERENCE:</b>	
<b>COST IMPACT:</b>	Yes (Unknown)	<b>SCHEDULE IMPACT:</b>	No
<b>DRAWING NUMBER:</b>		<b>SPEC SECTION:</b>	
<b>LINKED DRAWINGS:</b>	<a href="#">FS116</a>		
<b>RECEIVED FROM:</b>			
<b>COPIES TO:</b>	Dalton Fanning (Manhattan - Tulsa), Patrick Fogarty (Manhattan - Tulsa), Chris Griffin (Manhattan - Tulsa), Chad Stabers (Manhattan - Tulsa)		

### Question from Luke Wilson (Manhattan - Tulsa) at 01:38 PM on 04/18/2018

REF: Attached addendum 2 narrative and (Bid Package 2) SHEET FS116 FOOD SERVICE EQUIPMENT PRELIM. MEP CONNECTION PLAN, Plumbing Connections Schedule

- In the narrative for addendum #2 (attached), it states the addition of floor drains and mop sinks. Please provide a fixture schedule and specifications for these added floor drains and mop sinks.
- The FS116 schedule shows various "Pxx" items, many of which are to be installed in the slab on grade (Floor drains, Floor Sinks, Drains, Troughs, clean outs, etc.) Please provide a schedule showing exactly what to buy / install (brand, model #) for each in slab plumbing and food service item.

#### Attachments:

[addendum 2 narrative.pdf](#)

**Official Response:** Gary Moore (Childers) responded on Friday, April 20th, 2018 at 11:36AM CDT

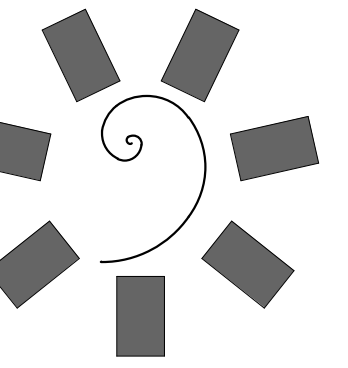
See attached plumbing schedule.  
Gary Moore

#### Attachments:

[TAHLEQUAH-P0-4 - PLUMBING SCHEDULES.pdf](#)

Coordinate and/or incorporate the enclosed clarifications to the Contract Documents as described in this RFI. Proceed with the clarifications described herein unless there is a cost or time impact to your work. If this RFI constitutes a change in cost or contract time to your scope, provide written notification of change to Manhattan within 48 hours of receipt of this RFI.





James R. Childers  
Architect, Inc.

45 South 4th Street  
Fort Smith, AR 72901  
479-783-2480  
www.childersarchitect.com

PROFESSIONAL SEAL

CONSULTANT LOGO



CLIENT:



CHEROKEE NATION ENTERTAINMENT  
TAHLEQUAH CASINO  
TAHLEQUAH, OKLAHOMA

PROJECT PHASE:

BID PACKAGE 02  
(17-06-SET)

REVISIONS

#	DESCRIPTION

DATE:

03/27/18

JOB NUMBER:

17-06

SHEET NUMBER:

P0.4

PLUMBING  
SCHEDULES

### PLUMBING FIXTURE SPECIFICATIONS

MARK	DESCRIPTION
WC-1	WATER CLOSET (ACCESSIBLE) - AMERICAN STANDARD #2294.011EC, VITREOUS CHINA, WHITE-O FINISH, WALL MOUNT, ELONGATED BOWL, SOLID PLASTIC OPEN FRONT SEAT, LESS COVER, AMERICAN STANDARD # 6065.121.002 BATTERY POWERED, SENSOR OPERATED FLUSHOMETER, 1.28 GPF, PROVIDE SUPPORT CARRIER BY JR SMITH OR ZURN. WC-1 SAME FIXTURE MOUNTED AT ACCESSIBLE RIM HEIGHT. REFER TO ARCHITECT'S ACCESSIBILITY DETAILS PRIOR TO ROUGH-IN.
WC-2	WATER CLOSET - AMERICAN STANDARD #2294.011EC, VITREOUS CHINA, WHITE-O FINISH, WALL MOUNT, ELONGATED BOWL, SOLID PLASTIC OPEN FRONT SEAT, LESS COVER, AMERICAN STANDARD #6065.121.002 BATTERY POWERED, SENSOR OPERATED FLUSHOMETER, 1.28 GPF, PROVIDE SUPPORT CARRIER BY JR SMITH OR ZURN. WC-1 SAME FIXTURE MOUNTED AT ACCESSIBLE RIM HEIGHT. REFER TO ARCHITECT'S ACCESSIBILITY DETAILS PRIOR TO ROUGH-IN.
WC-3	WATER CLOSET (ACCESSIBLE) - AMERICAN STANDARD 225BA-101 WHITE-O FINISH (RIGHT HAND TRIP LEVER "BLADE STYLE" IN POLISHED CHROME FINISH) AS REQUIRED, VITREOUS CHINA, FLOOR MOUNT, ELONGATED, TANK TYPE, WITH TANK LID LOCK, 1.28 GPF, SOLID PLASTIC CLOSED FRONT SEAT WITH COVER, 1/4 TURN STOP VALVE AND BRAIDED STAINLESS STEEL SUPPLY.
U-1	URINAL (ACCESSIBLE) - AMERICAN STANDARD DECORUM #6042.001EC, WALL HUNG, VITREOUS CHINA, 1 1/4" INLET SPUD, 0.125 GPF, 2" TOP SPUD, FRONT JETTED, BLOWDOWN-TYPE, 1 1/2" GLAZED TRAPWAY, FLUSHING RIM, FLUSH VALVE: AMERICAN STANDARD #6063.025.002, 0.125 GPF, BATTERY POWERED, SENSOR OPERATED, WHITE FINISH. COORDINATE WITH ARCHITECTURAL DRAWINGS FOR MOUNTING HEIGHTS PRIOR TO ROUGH-IN.
U-2	URINAL - AMERICAN STANDARD DECORUM #6042.001EC, WALL HUNG, VITREOUS CHINA, 1 1/4" INLET SPUD, 0.125 GPF, 2" TOP SPUD, FRONT JETTED, BLOWDOWN-TYPE, 1 1/2" GLAZED TRAPWAY, FLUSHING RIM, FLUSH VALVE: AMERICAN STANDARD #6063.025.002, 0.125 GPF, BATTERY POWERED, SENSOR OPERATED, WHITE FINISH. COORDINATE WITH ARCHITECTURAL DRAWINGS FOR MOUNTING HEIGHTS PRIOR TO ROUGH-IN.
L-1	LAVATORY (ACCESSIBLE) - KOHLER PENNINGTON K-2196-1R VITREOUS CHINA, DROP-IN, WHITE FINISH. FAUCET: SLOAN MODEL #EFX100, SENSOR OPERATED, BATTERY POWERED, 0.5 GPM, CHROME PLATED FINISH, LOOSE KEY STOPS, BRAIDED STAINLESS STEEL SUPPLY, GRID DRAIN, ADJUSTABLE P-TRAP. COORDINATE WITH ARCHITECTURAL DRAWINGS FOR MOUNTING HEIGHTS PRIOR TO ROUGH-IN. PROVIDE PIPE PROTECTION PER ADA REQUIREMENTS.
L-2	LAVATORY (ACCESSIBLE) - KOHLER KATHRYN K-2297 VITREOUS CHINA, UNDER COUNTER, WHITE FINISH. FAUCET: SLOAN MODEL #EFX100, SENSOR OPERATED, BATTERY POWERED, 0.5 GPM, CHROME PLATED FINISH, LOOSE KEY STOPS, BRAIDED STAINLESS STEEL SUPPLY, GRID DRAIN, ADJUSTABLE P-TRAP. COORDINATE WITH ARCHITECTURAL DRAWINGS FOR MOUNTING HEIGHTS PRIOR TO ROUGH-IN. PROVIDE PIPE PROTECTION PER ADA REQUIREMENTS.
L-3	LAVATORY (ACCESSIBLE) - KOHLER KINGSTON K-2007, ONE HOLE, VITREOUS CHINA, WALL HUNG, WHITE FINISH. FAUCET: SLOAN MODEL #EFX100, SENSOR OPERATED, BATTERY POWERED, 0.5 GPM, CHROME PLATED FINISH, LOOSE KEY STOPS, BRAIDED STAINLESS STEEL SUPPLY, GRID DRAIN, ADJUSTABLE P-TRAP. COORDINATE WITH ARCHITECTURAL DRAWINGS FOR MOUNTING HEIGHTS PRIOR TO ROUGH-IN. PROVIDE PIPE PROTECTION PER ADA REQUIREMENTS.
HS-1	HAND SINK (ACCESSIBLE) - ADVANCE TABCO #7-PS-68, 304 SERIES STAINLESS STEEL, WALL MOUNTED. FAUCET: CHICAGO FAUCETS #W4W-GN1AE35-317AB, 1.5 GPM AERATOR, 4" VANDAL PROOF WRISTBLADE HANDLE, WALL MOUNTED, GOOSENECK SPOUT.
EW-1	EMERGENCY EYEWASH - WALL HUNG, BRADLEY MODEL #S19-220B WITH THERMOSTATIC MIXING VALVE MODEL S19-2000, 10 3/4" DIA STAINLESS STEEL BOWL, TWIN SOFT-FLOW EYEWASH HEADS WITH PROTECTIVE SPRAYHEAD COVERS, 1/2" NPT STAY-OPEN BALL VALVE HAND OPERATED BY A HIGHLY VISIBLE SAFETY YELLOW HANDLE, INCLUDES MOUNTING BRACKET ONTO WALL.
EW-C-1	ELECTRIC WATER COOLER (ACCESSIBLE) - ELKAY MODEL #EZSTL8, MOUNTED FLUSH TO WALL, STAINLESS STEEL CONSTRUCTION, ONE PIECE STAINLESS STEEL BASIN, FRONT PUSH BUTTON OPERATORS, POLISHED FINISH. RATED AT 8.0 GPH CAPACITY, HFC-134a REFRIGERANT, 1/4 TURN ANGLE STOP, SEMI-CAST P-TRAP. INSTALL PER ADA REQUIREMENTS. REFER TO ARCHITECT'S ACCESSIBILITY DETAILS PRIOR TO ROUGH-IN.
EW-C-2	ELECTRIC WATER COOLER - ELKAY MODEL #ERPBM28K, WALL MOUNTED, STEEL CABINET, RECESSED REFRIGERATION SECTION, STAINLESS STEEL TOPS, FLEXI-GUARD SAFETY BUBBLERS, 7.5 GPH CAPACITY, FRONT PUSH BUTTON OPERATION, 1/4 TURN FIXTURE STOP, BRAIDED STAINLESS STEEL SUPPLY TUBE AND SEMI-CAST P-TRAP. COLOR AS SELECTED BY ARCHITECT. REFER TO ARCHITECTS ACCESSIBILITY DETAILS PRIOR TO ROUGH-IN.
MS-1	MOP SINK - FIAT MSB-3624, 36"x24" FLOOR MOUNT, POLYMER CONSTRUCTION, 832-AA HOSE AND BRACKET, 880-CC MOP HANGER, E-77AA VINYL RIM GUARDS, SYMMONS S-2490-CHKS WALL MOUNT BACK INLET SERVICE FAUCET WITH HOSE END SPOUT, PAIL HOOK, WALL BRACKET, INTEGRAL STOPS, CHECKS AND VACUUM BREAKER.
S-1	LAUNDRY SINK - TABCO 400 SERIES, DOUBLE COMPARTMENT, 16 GA. STAINLESS STEEL, 24"x24" BOWL SIZE, 48"x27.5" OVERALL.
FD-1	FLOOR DRAIN - FOR SHOWERS, TOILETS, TERRACE, AND KITCHENS, J.R. SMITH #2010A, CAST IRON BODY, 6" DIAMETER NICKEL BRONZE SQUARE HOLE GRATE, INTEGRAL FLASHING FLANGE AND TRAP PRIMER CONNECTION.
FD-2	FLOOR DRAIN - FOR CASINO AREA UNDER RAISED FLOOR, J.R. SMITH #2130, SHALLOW DRAIN, 12" DIAMETER ROUND TOP, DUCO CAST IRON BODY AND FLASHING COLLAR WITH CAST IRON BAR GRATE, MEDIUM DUTY.
FD-3	FLOOR DRAIN - FOR MECHANICAL AND UTILITY ROOMS, MEDIUM DUTY WITH 12" ROUND TOP, DUCO CAST IRON BODY AND FLASHING COLLAR WITH CAST IRON GRATE AND SLOTTED SEDIMENT BUCKET, "SAFE-SET" DESIGN INSURES BUCKET REPLACEMENT AFTER CLEANING SINCE TOP GRATE CANNOT BE INSERTED UNLESS BUCKET IS IN PLACE.
FS-1	FLOOR SINK - ZURN MODEL Z1900 12"x12" WITH 6" SUMP DEPTH, CAST IRON BODY AND SQUARE SLOTTED GRATE WITH ANTI-SPLASH ENAMEL INTERIOR AND TOP COATING.
FS-2	FLOOR SINK - ZURN MODEL Z1750 12"x12" WITH 6" SUMP DEPTH, 304 STAINLESS STEEL BODY AND SQUARE SLOTTED GRATE WITH ANTI-SPLASH STAINLESS STEEL STRAINER.
RD-1	ROOF DRAIN - J.R. SMITH #1010-ERC, CAST IRON BODY, CAST IRON OR CAST ALUMINUM DOME STRAINER, EXTENSION AS REQUIRED, SUMP RECEIVER AND UNDERDECK CLAMP.
ORD-1	OVERFLOW ROOF DRAIN - J.R. SMITH #1080-ERC, CAST IRON BODY, CAST IRON OR CAST ALUMINUM DOME STRAINER, EXTENSION AS REQUIRED, SUMP RECEIVER AND UNDERDECK CLAMP. INTEGRAL 2" HIGH SOLID WATER DAM.

### PLUMBING FIXTURE SPECIFICATIONS (CONT.)

MARK	DESCRIPTION
HB-1	HOSE BIBB - WOODFORD MODEL RB65, AUTOMATIC DRAINING FREEZELESS WALL HYDRANT IN BOX WITH VACUUM BREAKER AND LOOSE TEEKEY OPERATOR.
HB-2	ROOF TOP FREEZE PROOF HOSE BIBB - WOODFORD #SRH-MS 3/4" HOSE FAUCET WITH ASSE 1052 CERTIFIED DOUBLE CHECK VALVE BACKFLOW PREVENTER (FIELD TESTABLE), ROOF DECK SLEEVE / SUPPORT WITH UNDERDECK CLAMP AND RAIN BOOT..
HB-3	HOSE BIBB - TWO-TEMPERATURE, WOODFORD MODEL B22 FREEZELESS, ROUGH BRASS, CHROME PLATED HOSE VALVE, 3/4" HW AND 3/4" CW INLET TUBES/OPERATING HANDLES. INTEGRAL VACUUM BREAKER. HYDRANT IN CONCEALED BOX.
HB-4	HOSE BIBB - WOODFORD MODEL 40HT-LH, HALF-TURN WALL HYDRANT WITH LEVER HANDLE OPERATOR, WITH VACUUM BREAKER.
TD-1	TRENCH DRAIN - MIFAB MODEL P6030-29-42, 3" W x 42" x DESIRED LENGTH. TRENCH DRAIN - MIFAB MODEL P6030-29-42, 3" W x 42" LENGTH WITH STAINLESS STEEL BODY AND GRATE. PROVIDE WITH SLIP RESISTANT GRATE.

### WATER HAMMER ARRESTORS

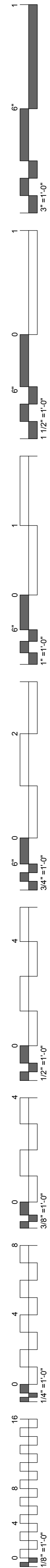
P.D.I. SYMBOL	CONN. SIZE, IN.	FIXTURE UNITS
A	3/4"	1 - 11
B	1"	12 - 32
C	1"	33 - 60
D	1"	61 - 113
E	1"	114 - 154
F	1"	155 - 330

NOTE: INSTALL AS PER MANUFACTURER MODEL'S RECOMMENDATIONS  
(P.D.I.) = PLUMBING DRAINAGE INSTITUTE STANDARDS.

### PLUMBING FIXTURE SCHEDULE

MARK	FIXTURE	ROUGH-IN (INCHES)						REMARKS
		C.W.	TW	HW	V	S/W	TRAP	
WC-1	WATER CLOSET	1	-	-	-	-	-	WALL MOUNT - ACCESSIBLE
WC-2	WATER CLOSET	1	-	-	-	-	-	WALL MOUNT
WC-3	WATER CLOSET	1	-	-	-	-	-	FLOOR MOUNT - ACCESSIBLE
U-1	URINAL	3/4	-	-	2	2	-	WALL HUNG - ACCESSIBLE
U-2	URINAL	3/4	-	-	2	2	-	WALL HUNG
L-1	LAVATORY	1/2	-	1/2	1 1/2	2	1 1/4 X 1 1/2	COUNTER
L-2	LAVATORY	1/2	-	1/2	1 1/2	2	-	UNDER MOUNT
L-3	LAVATORY	1/2	-	1/2	1 1/2	2	-	WALL MOUNTED
HS-1	HAND SINK	1/2	-	1/2	1 1/2	2	-	WALL MOUNTED
EW-1	EYE WASH	1/2	1/2	1/2	1 1/2	1 1/2	-	WALL MOUNTED
EW-C-1	WATER COOLER	1/2	-	-	1 1/2	2	-	ACCESSIBLE
EW-C-2	WATER COOLER	1/2	-	-	1 1/2	2	-	ACCESSIBLE
MS-1	MOP SINK	3/4	-	3/4	2	3	-	FLOOR MOUNT
S-1	SINK	1/2	-	1/2	1 1/2	2	-	-
FD-1	FLOOR DRAIN	-	-	-	-	-	-	SIZE AS SHOWN UNLESS NOTED OTHERWISE
FD-2	FLOOR DRAIN	-	-	-	-	-	-	SIZE AS SHOWN UNLESS NOTED OTHERWISE
FD-3	FLOOR DRAIN	-	-	-	-	-	-	SIZE AS SHOWN UNLESS NOTED OTHERWISE
FS-1	FLOOR SINK	-	-	-	-	-	-	SIZE AS SHOWN UNLESS NOTED OTHERWISE
RD-1	ROOF DRAIN	-	-	-	-	-	-	REFER TO DWGS. FOR EXACT SIZES
ORD-1	ROOF DRAIN	-	-	-	-	-	-	REFER TO DWGS. FOR EXACT SIZES
HB-1	HOSE BIBB	3/4	-	-	-	-	-	FREEZE PROOF RECESSED WALL BOX
HB-2	HOSE BIBB	3/4	-	-	-	-	-	FREEZE PROOF KEY OPERATED
HB-3	HOSE BIBB	3/4	-	-	-	-	-	FREEZE PROOF KEY OPERATED
HB-4	HOSE BIBB	3/4	-	-	-	-	-	-
TD-1	TROUGH DRAIN	-	-	-	-	-	-	SIZE AS SHOWN UNLESS NOTED OTHERWISE

PROVIDE STOPS ON ALL FIXTURES NOT FURNISHED WITH INTEGRAL STOPS. REFER TO PLANS FOR TEMPERED/HOT WATER LOCATIONS.



**SCOPE BID PACKAGE 22.01: – Underslab Mechanical and Plumbing**

**POST BID - BID FORM 4/25/18**

Submitted by (Company Name per W-9 Form): \_\_\_\_\_

1. CM Clarification #007 includes RFI #001. “RFI #001 Underslab Waste and Grease Waste Piping” confirms the grease waste piping material, and confirms the requirement to utilize heat trace on the stainless steel grease waste piping. Additionally, it is assumed at this time that two (2ea) control panels will be required for the grease waste system, and that Foam Glass insulation will be utilized for the grease waste piping.

The following *Lump Sum* amount shall be added to the Total Base Bid for completing the work as required by the contract documents, RFI #001, and as described in CM Clarification #007.

*Note: If the originally submitted Base Bid already includes this work as described in RFI #009, please write in “ZERO” below.*

\$ \_\_\_\_\_

2. CM Clarification #007 includes RFI #009. “RFI #009 Plumbing Fixtures” defines the plumbing fixtures related to the underslab plumbing. This scope of work was originally defined in Scope of Work Paragraphs 11 and 14 in Bid Package 22.01 Underslab Mechanical and Plumbing, and then later EXCLUDED from this scope in CM Clarification #006 dated April 19, 2018:

11. Provide all required clean-outs and architectural cover plates as required for plumbing work.
12. Review all drawings for any plumbing work identified therein. (E.G. Food Service troughs, floor sinks, floor drains, etc.)

The following *Lump Sum* amount shall be added to the Total Base Bid for completing the work as required by the contract documents, RFI #009, and as described in CM Clarification #007.

*Note: Trap Primers are still EXCLUDED from this scope of work.*

\$ \_\_\_\_\_

**TOTAL – CM CLARIFICATION 007 POST BID: \$ \_\_\_\_\_**