

Project: \_\_\_\_\_

Fixture Type: \_\_\_\_\_ Quantity: \_\_\_\_\_

Customer: \_\_\_\_\_

**Specifications**



**Material:**  
All parts are durable 356 cast aluminum. All hardware provided shall be stainless steel or zinc plated steel.

**Lens:**  
Choice of polycarbonate lens, acrylic lens or no lens.

**Fixture Mounting:**  
Post Mount: Post Cap with set screws.  
Pendant Mount: Pin mount to tenon.  
Fits 3" and 4" poles.

**Drivers:**  
Universal voltage 120-277 is standard. 0-10V dimming is standard for LED platforms.

See page 2 table for LED engine and driver specs, voltage and dimming protocols.

**Electrical:**  
20KA max/10KA nominal surge protection device is standard.

**Finish:**  
A polyester powder coat high quality finish is electro-statically applied and baked at 430° for exceptional durability and color retention. Products undergo an intensive five-step cleansing and pretreatment process for maximum paint adhesion.

Marine grade finish provides superior salt, humidity and UV protection. This coating withstands up to 3000 hours of continuous salt spray, comes with a 5-year warranty and is available in either a textured or gloss surface.

**Modifications:**  
Consult factory for custom or modified designs.

**LA604  
LED**

**Weight:** 27.0 lbs

**EPA:** 1.6

**Catalog Logic**

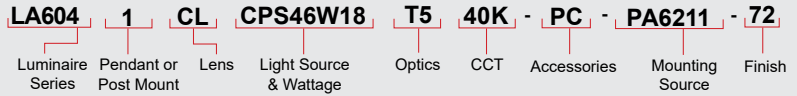

**Catalog Number**

1

2

3

4

5

6

7

8

**LA604 x 14**

**1 FIXTURE ORIENTATION**

- 1 Pendant

**2 LENS**

- CL (Clear Lens)
- FR (Frosted Acrylic)

**3 LIGHT SOURCE & WATTAGES**

- CPS30W18 (30W Ceramic LED)
- CPS39W18 (39W Platform LED/CA title 24)
- CPS46W18 (46W Ceramic LED)
- CPM78W30 (78W Ceramic LED)

**4 OPTICS**

- T2 (Type II)
- T3 (Type III)
- T5 (Type IV)

**5 COLOR TEMPERATURE (CCT)**

- 27K (2700K)
- 30K (3000K)
- 35K (3500K)
- 40K (4000K)

**6 ACCESSORIES**

- CHC (Clear Glass Chimney)
- CHF (Frosted Glass Chimney)
- HSS90 (90° House Side Shield, polished)
- HSS120 (120° House Side Shield, polished)
- 4ST36 (3 Ft, 1 1/4" Ridged Stem & Canopy)
- PEND-CH3 (3 Ft Pendant Chain & Canopy)
- \*EMG-LED20HV (20W, High Voltage LED Emergency Driver, remote placement, for use with Platforms, 78W or less)
- HLMSPC-06 (High-Low Motion Sensor/Photocell; 15' - 30' Sensor Mounting Height)
- HLMSPC-10 (High-Low Motion Sensor/Photocell; 8' - 15' Sensor Mounting Height)
- PC (Button Photo Cell)
- TLPC (Twist Lock photo cell & receptacle)
- TL (Twist Lock receptacle only)
- TL5 (5-pin Twist Lock receptacle only)
- TL7 (7-pin Twist Lock receptacle only)
- SF (Single Fusing)
- DFUSING (Dual Fusing)

\*For Emergency lumen output data, see Resources section at [www.ANPlighting.com](http://www.ANPlighting.com).

**7 MOUNTING SOURCE**

Post Mount Arms *See Page 3 for Style/Size		Wall Mount Arms *See Page 3 for Style/Size	
PA3111	PA8521	WM4511	WM8581
PA3113	PA8523	WM4513	WM8583
PA5151		WM5131	
PA5153		WM5133	
PA5411		WM5161	
PA5413		WM5163	
PA6211		WM5601	
PA6213		WM5603	
PA8031		WM6111	
PA8033		WM6113	
Column Mount *See Page 3 for Style/Size			
CM	Column Mount		

**8 FINISHES**

\*Premium and Marine Grade Finish have additional charges

Standard Colors	Standard Grade	Marine Grade*	Standard Colors	Standard Grade	Marine Grade*
Aspen Green	10	10M	Architectural Bronze	51	51M
Cantaloupe	11	11M	Patina Verde	52	52M
Lilac	12	12M	Copper Clay	53	53M
Putty	13	13M	Silver	56	56M
Raw Unfinished	40	NA	Black Verde	61	61M
Black	41	41M	Painted Chrome	70	70M
Forest Green	42	42M	Painted Copper	71	71M
Bright Red	43	43M	Textured Black	72	72M
White	44	44M	Matte Black	73	73M
Bright Blue	45	45M	Textured Architectural Bronze	76	76M
Sunny Yellow	46	46M	Textured White	77	77M
Aqua Green	47	47M	Textured Silver	78	78M
Galvanized	49	NA	PREMIUM FINISH	Premium Grade*	Marine Grade*
Navy	50	50M	Carbon Graphite	96	96M

Consult Factory for additional paint charges and availability.

Project: \_\_\_\_\_  
 Fixture Type: \_\_\_\_\_ Quantity: \_\_\_\_\_  
 Customer: \_\_\_\_\_

**LED PERFORMANCE**

**CERAMIC PLATFORM**

System Wattage (Nominal)	CCT	CRI	Type II		Type III		Type IV		Type V	
			Delivered Lumens	Lumens Per Watt	Delivered Lumens	Lumens Per Watt	Delivered Lumens	Lumens Per Watt	Delivered Lumens	Lumens Per Watt
30W	2700K	70	4373	146	4265	142	4493	150	4463	149
	3000K	70	4551	152	4439	148	4676	156	4646	155
	3500K	70	4586	153	4473	149	4712	157	4681	156
	4000K	70	4668	156	4553	152	4796	160	4765	159
39W	2700K	70	5681	146	5539	142	5753	150	5733	149
	3000K	70	5913	152	5764	148	5988	156	5967	155
	3500K	70	5958	153	5808	149	6033	157	6012	156
	4000K	70	6065	156	5913	152	6142	160	6120	159
46W	2700K	70	6701	146	6533	142	6786	150	6762	149
	3000K	70	6974	152	6799	148	7063	156	7038	155
	3500K	70	7027	153	6851	149	7116	157	7091	156
	4000K	70	7153	156	6974	152	7244	160	7219	159
78W	2700K	70	10678	138	10563	138	11246	144	11138	145
	3000K	70	11114	144	10994	143	11705	150	11593	151
	3500K	70	11198	145	11077	144	11793	151	11680	152
	4000K	70	11399	148	11276	147	12005	154	11890	155
90W	2700K	70	12728	137	12590	135	13404	144	13276	143
	3000K	70	13247	142	13104	141	13951	150	13818	148
	3500K	70	13347	143	13203	142	14057	151	13922	150
	4000K	70	13587	146	13440	144	14309	154	14172	152
120W	2700K	70	16637	137	16211	134	17215	142	17977	148
	3000K	70	17316	143	16872	139	17917	148	18711	154
	3500K	70	17447	144	17000	140	18052	149	18852	155
	4000K	70	17760	146	17305	143	18377	151	19191	158

**LED SPECIFICATIONS – CERAMIC PLATFORMS**

- Performance, Ceramic-cooling technology
- Up to 19,191 lumens
- Efficacy ranges from 134-159 lm/W
- Distributions: Types II, III, IV, V
- CCT: 2700K, 3000K, 3500K, 4000K
- Life: L70 > 50,000 hours
- Ingress Protection: IP66
- Certification: ETL
- CRI: >70

**DRIVER SPECIFICATION**

- Universal Input 120-277V
- 0-10V Dimming to 10%
- Power Factor @ Full Load >95%
- THD @ Full Load <10%
- Constant Current Output 50/60Hz
- Operating Temperature: -40°C Minimum
- Ingress Protection: IP66
- Certifications: UL Recognized, CSA, RoHS

Project: \_\_\_\_\_  
 Fixture Type: \_\_\_\_\_ Quantity: \_\_\_\_\_  
 Customer: \_\_\_\_\_

**SURGE SUPPRESSION**

- A Surge Protection Device (SPD) is standard featuring a 20KA maximum discharge current 8/20µs Waveform (Imax); 10KA nominal discharge current 8/20µs Waveform (In) and thermally protected varistor technology.
- Meets IEEE C62.41.2 Location Category C High and US Dept of Energy MSSLC Model Spec.
- SPD shall be wired in series and will result in an open circuit during a fault state, resulting in the luminaire to turn off to protect system components thereby indicating SPD module replacement.

**HIGH-LOW MOTION SENSOR (HLMSPC06 & HLMSPC10)**

- Sensor Type: 100% Digital PIR
- Line Voltage Sensor: 120-277 VAC
- Factory Defaults:
- Photocell: ON
- Light Levels: High / OFF
- Motion Time Delay: 5 min
- Ramp-up Rate: 3 sec
- Fade Down: 5 min
- High/Low and other settings are field-commissionable (others)
- Ingress Protection: IP66

**WARRANTY**

See [www.ANPlighting.com](http://www.ANPlighting.com) for complete fixture warranty.

LED warranty information

- 7 year limited warranty\* on Ceramic LED engines
- 5 year limited warranty\* on LED Drivers

\*Limited Warranty: A typical year is defined as 4380 hours of operation. Failed defined as more than 10% of the total platform LED's not operating.

**ACCESSORIES**



CHC & CHF



HSS90 & HSS120



4ST36



PEND-CH3



EMG-LED20HV



HLMSPC-06 & HLMSPC-10



PC



TLPC



TL5 & TL7

Project: \_\_\_\_\_

Fixture Type: \_\_\_\_\_ Quantity: \_\_\_\_\_

Customer: \_\_\_\_\_

**POST MOUNTS** - See Post Arm Section on Website for Specification Sheets and additional post arms.  
Dimensions are Projection x Height

**COLUMN MOUNT**



PA3111 / 25" x 15 1/4"

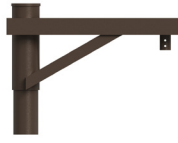

PA3113 / 25" x 15 1/4"



PA5151 / 14 1/4" x 19 3/4"



PA5153 / 14 1/4" x 19 3/4"



CM / 5 3/4" SQ x 3 1/2" H



PA5411 / 17 7/8" x 25 1/8"

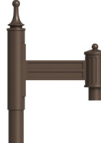

PA5413 / 17 7/8" x 25 1/8"



PA6211 / 22 3/4" x 26 1/2"



PA6213 / 22 3/4" x 26 1/2"



PA8031 / 20 1/2" x 20 1/4"



PA8033 / 20 1/2" x 20 1/4"

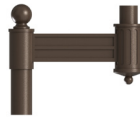

PA8521 / 18 1/4" x 14 1/2"



PA8523 / 18 1/4" x 14 1/2"

**WALL MOUNTS** - See Wall Mount Section on Website for Specification Sheets and additional wall mount arms.  
Dimensions are Projection x Height.



WM4511 / 17" x 8"



WM4513 / 17" x 8"



WM5131 / 11" x 16 3/8"



WM5133 / 11" x 16 3/8"

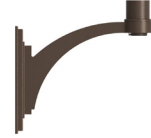

WM5161 / 15 3/4" x 13 3/4"



WM5163 / 15 3/4" x 13 3/4"



WM5601 / 17 7/8" x 14"



WM5603 / 17 7/8" x 14"



WM6111 / 20 3/8" x 24"



WM6113 / 20 3/8" x 24"



WM8581 / 17 1/8" x 17 1/2"

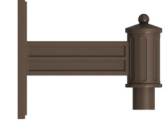

WM8583 / 17 1/8" x 17 1/2"

Project: \_\_\_\_\_

Fixture Type: \_\_\_\_\_ Quantity: \_\_\_\_\_

Customer: \_\_\_\_\_



Weight: 19.0 lbs  
EPA: 0.94

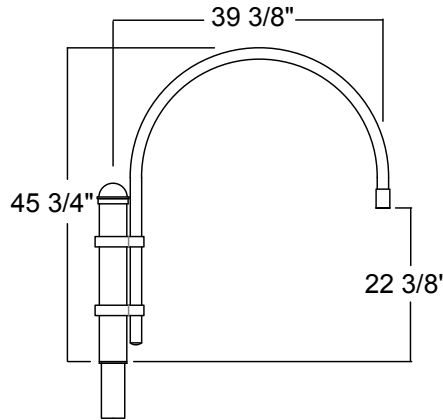

**Specifications**

**General:**  
Due to size or weight, arms mounts may not accommodate all ANP luminaires.

**Material:**  
All parts are durable 356 cast aluminum and high strength extruded aluminum. All hardware provided shall be stainless steel or zinc plated steel.

**Fixture Mounting:**  
Pin mount to tenon.

**Post Arm Mounting:**  
Slip tenon to accommodate 3", 4" and 5" pole. Pole section of arm matches pole diameter and style.

**Electrical:**  
Pull wire provided.

**Finish:**  
A polyester powder coat high quality finish is electro-statically applied and baked at 430° for exceptional durability and color retention. Products undergo an intensive five-step cleansing and pretreatment process for maximum paint adhesion.

Marine grade finish provides superior salt, humidity and UV protection. This coating withstands up to 3000 hours of continuous salt spray, comes with a 5-year warranty and is available in either a textured or gloss surface.

**Modifications:**  
Consult factory for custom or modified designs.

**PA261 - POST ARM**

Extruded and Cast Aluminum Post Arm for Pendant Fixture

**Catalog Logic**

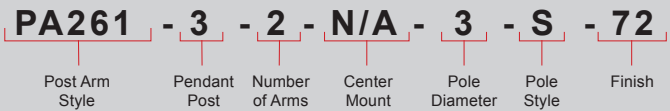

**Catalog Number**

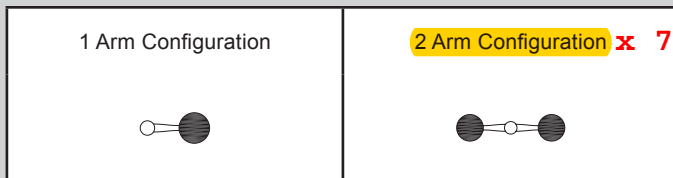
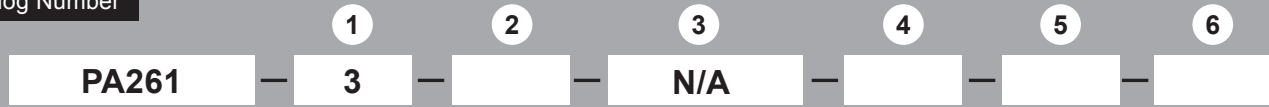

1	POST ARM ORIENTATION
3 - Pendant	

3	CENTER MOUNT OPTIONS
N/A	

6 FINISHES					
Standard Grade	Marine Grade		Standard Grade	Marine Grade	
40	NA	Raw Unfinished	53	100	Copper Clay
41	101	Black	56	109	Silver
42	102	Forest Green	61	106	Black Verde
43	114	Bright Red	70	118	Painted Chrome
44	107	White	71	105	Painted Copper
45	112	Bright Blue	72	108	Textured Black
46	123	Sunny Yellow	73	125	Matte Black
47	120	Aqua Green	76	121	Textured Architectural Bronze
49	NA	Galvanized	77	127	Textured White
50	111	Navy	78	124	Textured Silver
51	103	Architectural Bronze	10	130	Aspen Green
52	104	Patina Verde	11	131	Cantaloupe
12	133	Lilac	13	132	Putty

2	NUMBER OF ARMS
1 - One Arm Configuration	
2 - Two Arm Configuration	

4	POLE DIAMETER
3 - 3 Inch	
4 - 4 Inch	
5 - 5 Inch	

5	POLE STYLE
S - Smooth	
F - Fluted	

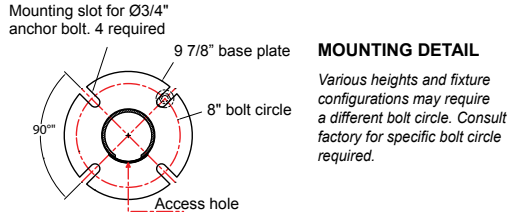
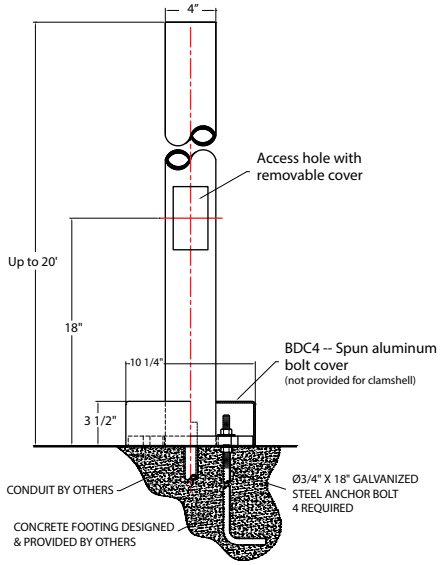

**Material**

Aluminum pole bases and base plates shall be cast from 356 aluminum alloy. Shafts shall be extruded 6061-T6 aluminum. Available in 3", 4" or 5" diameter. Wall thickness 0.125" or 0.188" or 0.250.

**Mounting**

Four anchor bolts provided are 3/4"x18". Anchor bolts, nuts and washers are hot dipped galvanized steel. Spun aluminum bolt cover provided.

**Access**

All poles are provided with a hand access opening and cover. Hand hole cover is secured by two stainless steel machine screws. (Tamper-proof screws provided upon request).

**Grounding**

All poles are provided with an aluminum grounding lug integrated to inner wall of shaft, 180 degrees to hand hole. Grounding lug is drilled and tapped to accommodate 1/4"-20 stainless steel machine screw.

**Pole Height**

Maximum pole height is 20-feet.

**Accessories**

Banner arms, ladder rests, signage, flag pole holder and GFI receptacles are optional.

**Finish**

A polyester powder coat high quality finish is electro-statically applied and baked at 430° for exceptional durability and color retention. Products undergo an intensive five-step cleansing and pretreatment process for maximum paint adhesion.

Marine grade finish provides superior salt, humidity, and UV protection. This coating withstands up to 3000 hours of continuous salt spray, comes with a 5-year warranty and is available in either a textured or gloss surface.

Project: \_\_\_\_\_

Fixture Type: \_\_\_\_\_ Quantity: \_\_\_\_\_

Customer: \_\_\_\_\_



**Catalog Logic**

**BD3S10.125** - **BAA** - **CCS1902** - **41**  
 Pole Accessory Clamshell Finish

**Catalog Number**

1 2 3 4

See page 2 for more ordering info

1	Item Number	OD	Height	Wall	80 MPH	100 MPH
	BD3S3	3	3	0.125	10.10	6.20
	BD3S4	3	4	0.125	9.20	5.30
	BD3S5	3	5	0.125	8.00	4.70
	BD3S6	3	6	0.125	6.90	4.00
	BD3S7	3	7	0.125	6.00	3.60
	BD3S8	3	8	0.125	5.20	3.00
	BD3S9	3	9	0.125	4.50	2.60
	BD3S10	3	10	0.125	3.90	2.00
	BD3S11	3	11	0.125	3.40	1.70
	BD3S12	3	12	0.125	2.90	1.30
	BD4S3	4	3	0.125	27.60	17.50
	BD4S4	4	4	0.125	22.10	14.00
	BD4S5	4	5	0.125	19.90	12.60
	BD4S6	4	6	0.125	17.70	11.25
	BD4S7	4	7	0.125	16.00	10.10
	BD4S8	4	8	0.125	14.20	9.00
	BD4S9	4	9	0.125	12.00	7.60
	BD4S10	4	10	0.125	10.10	6.20
	BD4S11	4	11	0.125	8.80	5.30
	BD4S12	4	12	0.125	7.50	4.40
	BD4S13	4	13	0.125	6.00	3.50
	BD4S14	4	14	0.125	5.50	2.70
	BD4S5	4	5	0.188	33.10	21.00
	BD4S6	4	6	0.188	29.50	18.70
	BD4S7	4	7	0.188	27.60	16.80
	BD4S8	4	8	0.188	23.60	15.00
	BD4S9	4	9	0.188	20.00	12.60
	BD4S10	4	10	0.188	16.80	10.30
	BD4S11	4	11	0.188	14.60	8.80
	BD4S12	4	12	0.188	12.50	7.30
	BD4S13	4	13	0.188	10.00	5.80
	BD4S14	4	14	0.188	9.10	4.50
	BD4S15	4	15	0.188	8.10	3.60
	BD4S16	4	16	0.188	7.20	2.80
	BD5S6	5	6	0.125	30.00	19.30
	BD5S7	5	7	0.125	27.10	17.40
	BD5S8	5	8	0.125	24.00	15.50
	BD5S9	5	9	0.125	21.60	13.90
	BD5S10	5	10	0.125	19.20	12.40
	BD5S11	5	11	0.125	17.10	10.80
	BD5S12	5	12	0.125	15.00	9.30
	BD5S13	5	13	0.125	12.80	8.10
	BD5S14	5	14	0.125	11.50	7.00
	<b>BD5S15</b>	<b>5</b>	<b>15</b>	<b>0.125</b>	<b>10.10</b>	<b>6.00</b>
	BD5S16	5	16	0.125	8.80	5.10
	BD5S17	5	17	0.125	7.70	4.30
	BD5S18	5	18	0.125	6.80	3.60
	BD5S19	5	19	0.125	5.70	2.80
	BD5S20	5	20	0.125	4.70	2.20
	BD5S7	5	7	0.188	32.80	25.70
	BD5S8	5	8	0.188	29.30	22.80
	BD5S9	5	9	0.188	26.40	20.50
	BD5S10	5	10	0.188	23.50	18.20
	BD5S11	5	11	0.188	21.00	16.40
	BD5S12	5	12	0.188	18.60	14.60
	BD5S13	5	13	0.188	16.70	13.00
	BD5S14	5	14	0.188	14.80	11.40
	BD5S15	5	15	0.188	13.30	10.40
	BD5S16	5	16	0.188	11.80	9.00
	BD5S17	5	17	0.188	10.50	7.90
	BD5S18	5	18	0.188	9.20	6.80
	BD5S19	5	19	0.188	8.20	5.90
	BD5S20	5	20	0.188	7.20	5.00

Project: \_\_\_\_\_

Fixture Type: \_\_\_\_\_ Quantity: \_\_\_\_\_

Customer: \_\_\_\_\_

### 2 ACCESSORIES

**GF15** (15 amp GFCI receptacle outlet) 

**GF120** (20 amp GFCI receptacle outlet)

**GF1-WPU** (20 amp GFCI receptacle with weather proof in-use cover)

**BAA** (Cast Banner Arm A for 24" wide banner) 

**BAB** (Cast Banner Arm B for 30" wide banner) 

**BAC** (Cast Banner Arm C for 30" wide banner) 

**LR1** (Cast Ladder Rest 1) 

**LR3** (Cast Ladder Rest 3) 

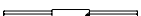
**LR4** (Cast Ladder Rest 4) 

**LR5** (Cast Ladder Rest 5) 

**SIGN A** (Cast Sign A; 30" x 9", 8 letters/numbers on one line; requires Banner Arm to hang) 

**SIGN B** (Cast Sign B; 31" x 7", 12 letters/numbers on one line; requires Banner Arm to hang) 

**SIGN C** (Cast Sign C; 27" x 11", two rows of 8 letters/numbers on each line, requires Banner Arm to hang) 

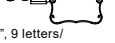
**SIGN D** (Cast Sign D; 11" x 6 1/2", 4 letters/numbers on one line) 

**SIGN E** (Cast Sign E; comes with pole clamp, 24 1/2" x 6", 9 letters/numbers on one line) 

**FPH1** (Flag Pole Holder) 

**TP** (Tamper Proof Screws)

**BDC** (Spun Aluminum Bolt cover) 

**SBDC** (Split Bolt Cover) 























### 4 FINISHES

\*Premium and Marine Grade Finish have additional charges

Standard Colors	Standard Grade	Marine Grade*	Standard Colors	Standard Grade	Marine Grade*
Aspen Green	10	10M	Architectural Bronze	51	51M
Cantaloupe	11	11M	Patina Verde	52	52M
Lilac	12	12M	Copper Clay	53	53M
Putty	13	13M	Silver	56	56M
Raw Unfinished	40	NA	Black Verde	61	61M
Black	41	41M	Painted Chrome	70	70M
Forest Green	42	42M	Painted Copper	71	71M
Bright Red	43	43M	Textured Black	72	72M
White	44	44M	Matte Black	73	73M
Bright Blue	45	45M	Textured Architectural Bronze	76	76M
Sunny Yellow	46	46M	Textured White	77	77M
Aqua Green	47	47M	Textured Silver	78	78M
Galvanized	49	NA	<b>PREMIUM FINISH</b>	Premium Grade*	Marine Grade*
Navy	50	50M	Carbon Graphite	96	96M
			Wood Grain	99	NA

Consult Factory for additional paint charges and availability.

### 3 2-PIECE CLAMSHELLS

CCS0300 	CCS1302 	CCS2902 
CCS0509 	CCS1501 	CCS2903 
CCS0701 	CCS1502 	CCS5301 
CCS0702 	CCS1504 	CCS5401 
CCS0900 	CCS1509 	CCS5509 
CCS1100 	CCS1607 	CCS6303 
CCS1201 	CCS1608 	CCS6502 
CCS1301 	CCS1902 	CCS9103 